



Ruijie Reyee RG-EG V2 Series Routers

Hardware Installation and Reference Guide

Copyright Statement

Ruijie Networks©2021

Ruijie Networks reserves all copyrights of this document. Any reproduction, excerpt, backup, modification, transmission, translation or commercial use of this document or any portion of this document, in any form or by any means, without the prior written consent of Ruijie Networks is prohibited.

Exemption Statement

This document is provided "as is". The contents of this document are subject to change without any notice. Please obtain the latest information through the Ruijie Networks website. Ruijie Networks endeavors to ensure content accuracy and will not shoulder any responsibility for losses and damages caused due to content omissions, inaccuracies or errors.

Preface

Thank you for using our products. This manual will guide you through the installation of the device.

This manual describes the functional and physical features and provides the device installation steps, hardware troubleshooting, module technical specifications, and specifications and usage guidelines for cables and connectors.

Audience

It is intended for the users who have some experience in installing and maintaining network hardware. At the same time, it is assumed that the users are already familiar with the related terms and concepts.

Obtaining Technical Assistance

- Ruijie Networks Website: <https://www.ruijienetworks.com/>
- Technical Support Website: <https://ruijienetworks.com/support>
- Case Portal: <https://caseportal.ruijienetworks.com>
- Community: <https://community.ruijienetworks.com>
- Technical Support Email: service_rj@ruijienetworks.com
- Skype: [service_rj@ruijienetworks.com](https://www.skype.com/people/service_rj@ruijienetworks.com)

Related Documents

Documents	Description
Configuration Guide	Describes network protocols and related mechanisms that supported by the product, with configuration examples.
Command Reference	Describes the related configuration commands, including command modes, parameter descriptions, usage guides, and related examples.

Symbol Conventions

 Means reader take note. Notes contain helpful suggestions or references.

 Means reader be careful. In this situation, you might do something that could result in equipment damage or loss of data.

1 Product Overview

Featured with global-leading semiconductor technologies and communication control technologies, Ruijie RG-EG V2 series router is a data communication product developed by Ruijie Networks with independent intellectual property right. The RG-EG V2 series router is designed according to international standards, similar to the mainstream router products in the international market. By reading this manual, a network administrator familiar with mainstream router configuration commands can use this device without training.

1.1 RG-EG105G V2

Specifications

Model	RG-EG105G V2
CPU	Dual-core CPU with the clock speed of 880MHz
Flash Memory	16MB
SDRAM	DDRIII 128MB
Power Module	AC input: Rated voltage range: 100V to 240V Maximum voltage range: 90V to 264V Frequency: 50/60 Hz Rated current: 0.5A
DC Connector	Inner diameter: 1.35mm Outer diameter: 3.5mm Inner pole: positive Outer pole: negative
EEE	Not supported
PoE	Not supported
Power Consumption	< 12W
Working Temperature	0°C to 40°C (32°F to 104°F)
Storage Temperature	-40°C to 70°C (-40°F to 158°F)
Working Humidity	10% to 90% RH
Storage Humidity	5% to 95% RH
Fan	N/A
Temperature Warning	Not supported
EMC Standards	GB9254 CLASS A EN 55032:2015+AC:2016 EN 61000-3-2:2014 EN 61000-3-3:2013

	EN 55035:2017 ETSI EN 300 386 V2.1.1 (2016-07)
Safety Standards	GB4943-2011 EN 62368-1
Dimensions (without rubber pads) (W x H x D)	206.5 mm x 28 mm x 108.5 mm (8.13 in. x 1.1 in. x 4.27 in.)
Weight	0.55kg

 Use the power adapter provided by Ruijie.

Appearance

Figure 1-1 Appearance of RG-EG105G V2

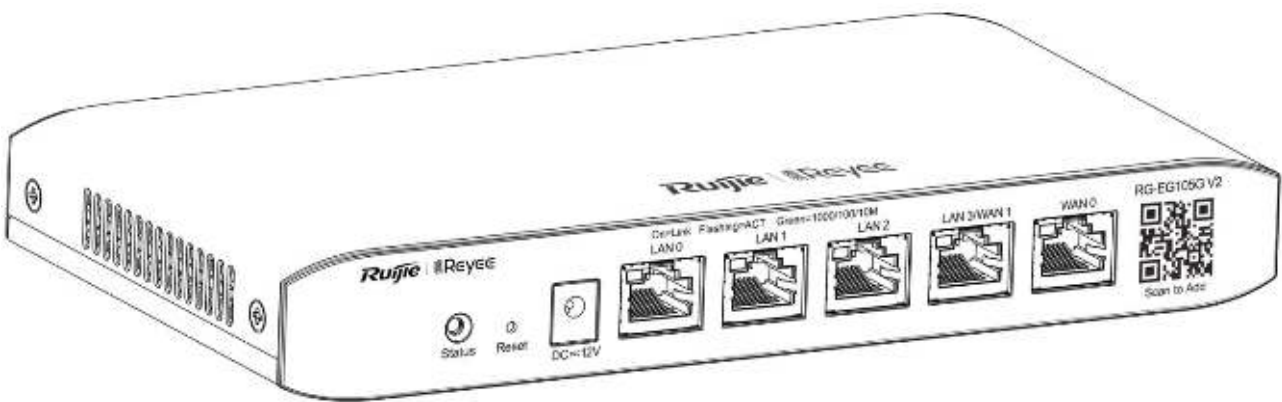
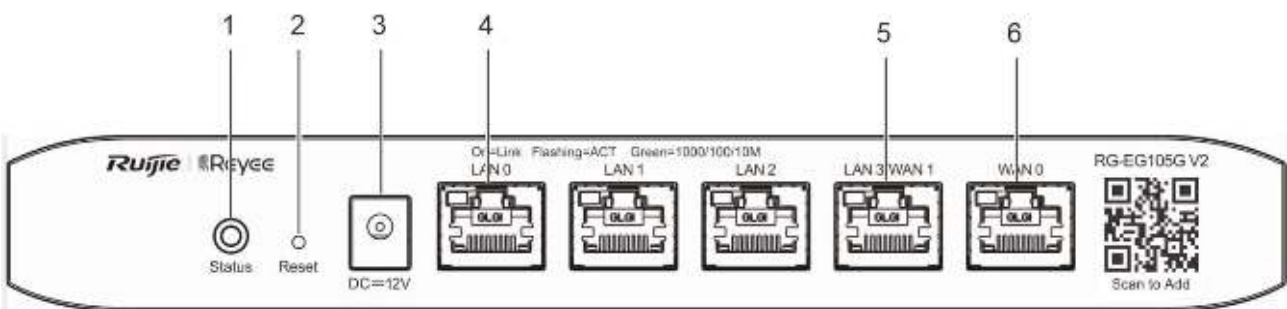

Figure 1-2 Front Panel of RG-EG105G V2



Note	1. System status LED	4. LAN ports
	2. Reset button	5. LAN/WAN port
	3. Power supply	6. WAN port

 **Reset button:** Press the button for less than 2 seconds, the system will restart; press for more than 5 seconds until the system status LED blinks, the system will restore the factory settings and restart. After the device restores the factory settings, the default management address is <http://192.168.110.1>.

Figure 1-3 Back Panel of RG-EG105G V2



Power Supply

The RG-EG105G V2 router adopts AC power input.

- AC input:

Rated voltage range: 100V to 240V, 50Hz/60Hz

Maximum voltage range: 90V to 264V, 47Hz to 63Hz

Frequency: 50Hz/60Hz

Rated current: 0.5A

Heat Dissipation

The RG-EG105G V2 adopts natural heat dissipation, thereby ensuring normal function of the device in the specified environment. 10 cm distance space should be reserved at both sides and the back plane of the cabinet to allow air circulation. It is recommended to clean the device once every 3 months to avoid dust from blocking vents.

Port

Port	Description
WAN	1 WAN port, used to connect to the DSL/Cable modem for Internet access.
LAN	4 LAN ports, used to connect to the computer or switch. The port LAN 3 can be used as a WAN port via the Web configuration.

LED Indicator

LED Indicator	Description
Status	Blinking green (0.5Hz): The device is not connected to Ruijie Cloud. Solid green: The device has started up, and is connected to Ruijie Cloud. Blinking green (10Hz): The device is restoring the factory settings or starting up.
Link/ACT	Solid green: The port is up. Blinking green: Data are being forwarded on the port.

1.2 RG-EG105G-P V2

Specifications

Model	RG-EG105G-P V2
CPU	Dual-core CPU with the clock speed of 880MHz
Flash Memory	16MB
SDRAM	DDRIII 128MB

Power Module	AC input: Rated voltage range: 100V to 240V Maximum voltage range: 90V to 264V Frequency: 50/60 Hz Rated current: 1.5A
DC Connector	Inner diameter: 2.1mm Outer diameter: 5.5mm Inner pole: positive Outer pole: negative
EEE	Not supported
PoE	IEEE 802.3af/at, 54W max output
Power Consumption	< 60W
Working Temperature	0°C to 40°C (32°F to 104°F)
Storage Temperature	-40°C to 70°C (-40°F to 158°F)
Working Humidity	10% to 90% RH
Storage Humidity	5% to 95% RH
Fan	N/A
Temperature Warning	Not supported
EMC Standards	GB9254 CLASS A EN 55032:2015+AC:2016 EN 61000-3-2:2014 EN 61000-3-3:2013 EN 55035:2017 ETSI EN 300 386 V2.1.1 (2016-07)
Safety Standards	GB4943-2011 EN 62368-1
Dimensions (without rubber pads) (W x H x D)	206.5 mm x 28 mm x 108.5 mm (8.13 in. x 1.1 in. x 4.27 in.)
Weight	0.75kg

 Use the power adapter provided by Ruijie.

Appearance

Figure 1-4 Appearance of RG-EG105G-P V2

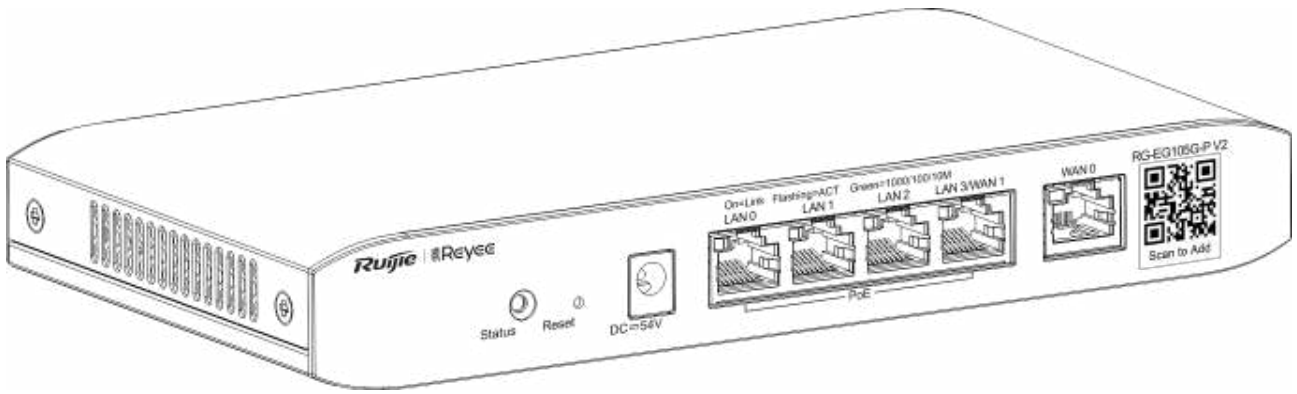
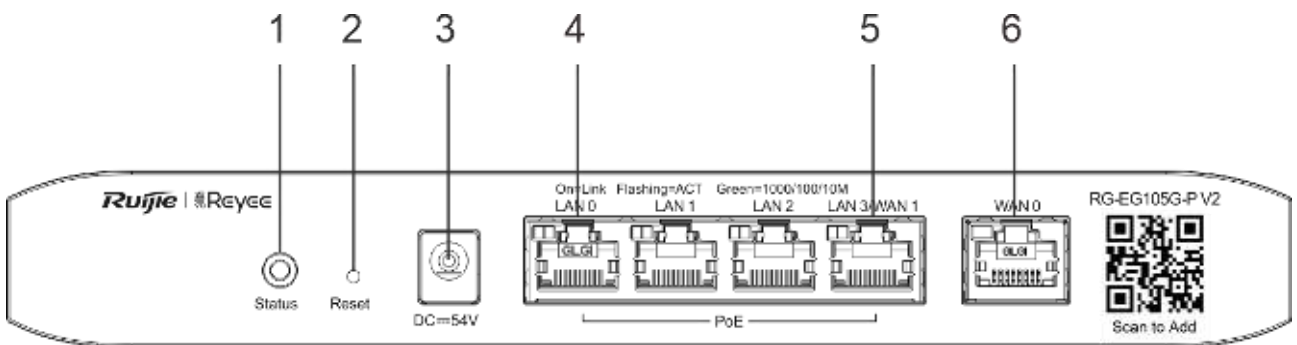

Figure 1-5 Front Panel of RG-EG105G-P V2



Note	1. System status LED	4. LAN ports
	2. Reset button	5. LAN/WAN port
	3. Power supply	6. WAN port

! Reset button: Press the button for less than 2 seconds, the system will restart; press for more than 5 seconds until the system status LED blinks, the system will restore the factory settings and restart. After the device restores the factory settings, the default management address is <http://192.168.110.1>.

Figure 1-6 Back Panel of RG-EG105G-P V2

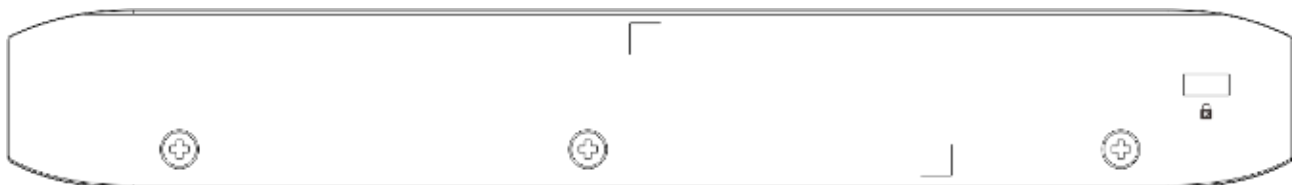

Power Supply

The RG-EG105G-P V2 router adopts AC power input.

- AC input:

Rated voltage range: 100V to 240V, 50Hz/60Hz

Maximum voltage range: 90V to 264V, 47Hz to 63Hz

Frequency: 50Hz/60Hz

Rated current: 1.5A

Heat Dissipation

The RG-EG105G V2 adopts natural heat dissipation, thereby ensuring normal function of the device in the specified environment. 10 cm distance space should be reserved at both sides and the back plane of the cabinet to allow air circulation. It is recommended to clean the device once every 3 months to avoid dust from blocking vents.

Port



Port	Description
WAN	1 WAN port, used to connect to the DSL/Cable modem for Internet access .
LAN	4 LAN ports, used to connect to the computer or switch. The port LAN 3 can be used as a WAN port via the Web configuration.

LED Indicator

LED Indicator	Description
Status	Blinking green (0.5Hz): The device is not connected to Ruijie Cloud or PoE is overcurrent. Solid green: The device has started up, and is connected to Ruijie Cloud. Blinking green (10Hz): The device is restoring the factory settings or starting up.
Link/ACT	Solid green: The port is up. Blinking green: Data are being forwarded on the port.

2 Preparation before Installation

2.1 Safety Suggestions

-
-  To avoid personal injury and equipment damage, please carefully read the safety suggestions before you install the RG-EG V2 series router.
 -  The following safety suggestions do not cover all possible dangers.
-

2.1.1 Installation

- Keep the chassis clean and free from any dust.
- Do not place the equipment in a walking area.
- Do not wear loose clothes or accessories that may be hooked or caught by the device during installation and maintenance.

2.1.2 Movement

- Do not frequently move the device.
- When moving the device, note the balance and avoid hurting legs and feet or straining the back.
- Before moving the device, turn off all power supplies and dismantle all power modules.

2.1.3 Electricity

- Observe local regulations and specifications when performing electric operations. Relevant operators must be qualified.
- Before installing the device, carefully check any potential danger in the surroundings, such as ungrounded power supply, and damp/wet ground or floor.
- Before installing the device, find out the location of the emergency power supply switch in the room. First cut off the power supply in the case of an accident.
- Try to avoid maintaining the switch that is powered-on alone.
- Be sure to make a careful check before you shut down the power supply.
- Do not place the equipment in a damp location. Do not let any liquid enter the chassis.

 Any non-standard and inappropriate electric operations may cause an accident such as a fire or electrical shock, thus causing severe even fatal damage to human bodies and equipment.

 Direct or indirect touch through a wet object on high-voltage and commercial electricity may bring a fatal danger.

 If a power supply system is equipped with a leakage protector (also referred to as "leakage current switch" or "leakage current breaker"), the rated leakage action current of each leakage protector is greater than twice of the theoretical maximum leakage current of all the power supplies in the system. For example, if a system is equipped with eight identical power supplies, the leakage current of each power supply is equal to or less than 3.5 mA, and the leakage current of the system totals 56 mA. A leakage protector with 30 mA rated action current supports less than five power

supplies (that is, Action current of the leakage protector/2/Maximum leakage current of each power supply = 30/2/3.5 = 4.28). In other words, the leakage protector with 30 mA rated action current supports no more than four power supplies. In this case, the sixteen power supplies in the system require at least four leakage protectors with 30 mA rated action current and each leakage protector supports four power supplies. If power supplies in a system differ in models, the rated leakage action current of each leakage protector divided by two is greater than the sum of maximum leakage currents of all the power supplies. The rated leakage non-action current of a leakage protector shall be 50% of the leakage action current. Take a leakage protector with 30 mA rated leakage action current as an example. The rated leakage non-action current shall be 15 mA. When the leakage current is below 15 mA, the protector shall not act. Otherwise, misoperation may easily occur due to high sensitivity and thus the leakage protector trips, devices are powered off, and services are interrupted.



To guarantee personal safety, the rated leakage action current of each leakage protector in the system must be equal to or less than 30 mA (human body safety current is 30 mA). When twice of the total leakage current of the system is greater than 30 mA, the system must be equipped with two or more leakage protectors.



For the leakage current value of each power supply model, see the power supply model parameter table in Chapter 1.

2.1.4 Static Discharge Damage Prevention

To prevent damage from static electricity, pay attention to the following:

- Proper grounding of grounding screws on the back panel of the device.
- Indoor dust prevention
- Proper humidity conditions

2.2 Installation Site Requirements

To ensure the normal working and a prolonged durable life of the equipment, the installation site must meet the following requirements.

2.2.1 Installation Site

If the router is installed in the cabinet, the following requirements shall be met:

- Make sure sufficient room has been reserved for the air intake and air vent of router to facilitate the heat elimination of the router chassis.
- Make sure the cabinet is equipped with a good ventilation and cooling system.
- Make sure the cabinet and workbench is steady enough and capable of withstanding the weight of the router and its accessories.
- Make sure the cabinet is properly grounded.

2.2.2 Ventilation

For the router, a sufficient space (at least 10 cm distances from both sides and the back plane of the cabinet) should be reserved at the ventilation openings to ensure the normal ventilation. After various cables have been connected, they should be arranged into bundles or placed on the cabling rack to avoid blocking the air inlets. It is recommended to clean

the router at regular intervals (like once every 3 months). Especially, avoid dust from blocking the screen mesh on the back of the cabinet.

2.2.3 Temperature and Humidity

To ensure the normal operation and prolong the service life of router, you should keep proper temperature and humidity in the equipment room.

If the equipment room has temperature and humidity that do not meet the requirements for a long time, the equipment may be damaged.

- In an environment with relatively high humidity, the insulating material may have bad insulation or even leak electricity. Sometimes the materials may suffer from mechanical performance change and metallic parts may get rusted.
- In an environment with relatively low humidity, however, the insulating strip may dry and shrink. Static electricity may occur easily and endanger the circuit on the equipment.
- In an environment with high temperature, the equipment is subject to even greater harm, as its performance may degrade significantly and various hardware faults may occur.

Table 2-1 Temperature and Humidity Requirements of the RG-EG V2 Series Router

Temperature	Relative Humidity
0 °C to 40°C (32°F to 104°F)	10% to 90% (-40°F to 158°F)

i The requirements for the sampling site of the temperature and humidity in the operating environment of the device are as follows:

There is no protective plate at the front or back of the equipment rack.

The vertical height is 1.5 m above the floor.

The distance from the front panel of the equipment is 0.4 m.

2.2.4 Cleanness

Dust poses a severe threat to the running of the equipment. The indoor dust falling on the equipment may be adhered by the static electricity, causing bad contact of the metallic joint. Such electrostatic adherence may occur more easily when the relative humidity is low, not only affecting the useful life of the equipment, but also causing communication faults.

Table 2-2 Requirements for the Dust Content and Granularity in the Equipment Room

Dust	Unit	Density
Diameter $\geq 0.5\mu\text{m}$	Particles/ m^3	$\leq 3.5 \times 10^6$
Diameter $\geq 5\mu\text{m}$	Particles/ m^3	$\leq 3 \times 10^4$

Apart from dust, the salt, acid and sulfide in the air in the equipment room must also meet strict requirements, as such poisonous substances may accelerate the corrosion of the metal and the aging of some parts. The equipment room should be protected from the intrusion of harmful gases such as sulfur dioxide, sulfured hydrogen, nitrogen dioxide, and chlorine.

Table 2-3 Requirements for Harmful Gases in the Equipment Room

Gas	Average (mg/ m^3)	Maximum (mg/ m^3)
-----	-----------------------------	-----------------------------

SO ₂	0.3	1.0
H ₂ S	0.1	0.5
NO ₂	0.5	1.0
Cl ₂	0.1	0.3

2.2.5 Grounding

A good grounding system is the basis for the stable and reliable operation of the RG-EG V2 series router. It is the chief condition to prevent lightning stroke and resist interference. Please carefully check the grounding conditions on the installation site according to the grounding requirements, and perform grounding operations properly as required.

Lightning Grounding

The lightning protection system of a facility is an independent system that consists of the lightning rod, downlead conductor and the connector to the grounding system, which usually shares the power reference ground and yellow/green safety cable ground. The lightning discharge ground is for the facility only, irrelevant to the equipment.

EMC Grounding

The grounding required for EMC design includes shielding ground, filter ground, noise and interference suppression, and level reference. All the above constitute the comprehensive grounding requirements. The resistance of earth wires should be less than 1Ω.



RG-EG V2 is a class A product. In a domestic environment, this product may cause radio interference in which case the user may be required to take adequate measures.

2.2.6 EMI

Electro-Magnetic Interference (EMI), from either outside or inside the equipment or application system, affects the system in the conductive ways such as capacitive coupling, inductive coupling, and electromagnetic radiation.

There are two types of electromagnetic interference: radiated interference and conducted interference, depending on the type of the transmission path.

When the energy, often RF energy, from a component arrives at a sensitive component via the space, the energy is known as radiated interference. The interference source can be either a part of the interfered system or a completely electrically isolated unit. Conducted interference results from the electromagnetic wire or signal cable connection between the source and the sensitive component, along which cable the interference conducts from one unit to another. Conducted interference often affects the power supply of the equipment, but can be controlled by a filter. Radiated interference may affect any signal path in the equipment and is difficult to shield.

- Effective measures should be taken for the power system to prevent the interference from the electric grid.
- The working ground of the routers should be properly separated and kept as far as possible from the grounding device of the electrical equipment or the anti-lightning grounding device.
- Keep the equipment away from high-power radio transmitter, radar transmitting station, and high-frequency large-current device.
- Measures must be taken to shield static electricity.

2.2.7 Mounting

The router supports wall mounting. The recommended screws and wall anchors are listed in the following table:

Type	Specification	Quantity
Pan-head self-tapping screw with cross recess	ST4.2*20PWA-9mm	2
Plastic wall anchor	4*20 wall anchor for self-tapping screw	2

2.3 Installation Tool Requirements

Table 2-4 List of Installation Tools

Common Tools	Phillips screwdriver, related copper and fiber cables, bolts, diagonal pliers, cable ties
Special Tools	Wire stripper, crimping pliers, RJ-45 crimping pliers, punch down tool
Meter	Multimeter

 The tool kit is customer-supplied.

3 Installing the Router

3.1 Installation Flowchart

Please take the following steps:

Figure 3-1 Installation Flowchart

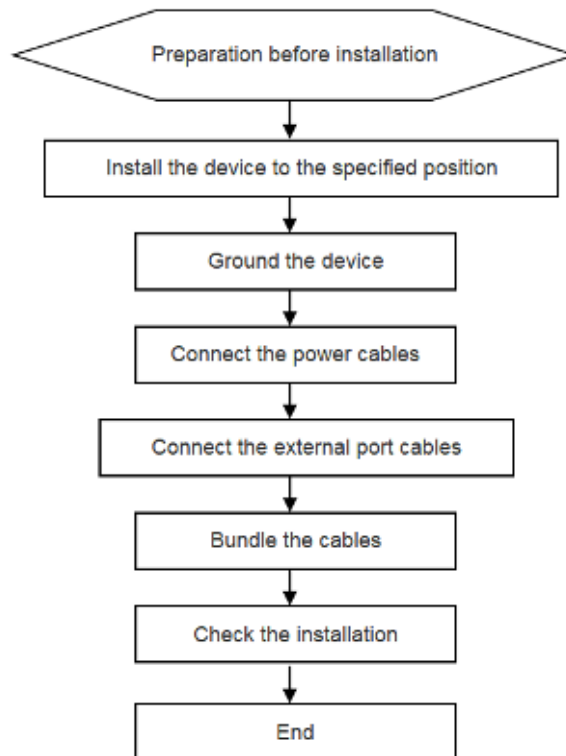

3.2 Confirmations before Installation

Before installation, please confirm the following points:

- Whether ventilation requirements are met for the device
- Whether the requirements of temperature and humidity are met for the device
- Whether power cables are already laid out and whether the requirements of electrical current are met
- Whether related network adaption lines are already laid out

3.3 Mounting the Router

3.3.1 Mounting the Router to a Standard 19-inch Cabinet

Please note that RG-EG105G V2 and RG-EG105G-P V2 can not be mounted to a cabinet.

3.3.2 Mounting the Router to a Workbench

Please place the router on a clean workbench. The operation is as follows:

Step 1: Attach the four rubber pads to the four corners on the bottom.

Step 2: Place the router on the workbench and ensure good ventilation condition around the router.

3.4 Installing Power Cables

RG-EG105G V2 router uses 2-conductor power cables. You are suggested to use a single-phase 2-conductor outlet or a multifunction microcomputer outlet with neutral connector.

RG-EG105G-P V2 series router uses 3-conductor power cables. You are suggested to use a single-phase 3-conductor outlet or a multifunction microcomputer outlet with neutral connector. The neutral point of the power supply shall be securely grounded in the building. In most buildings, the neutral point of a power supply has been grounded during the construction. You need to make sure the power supply is properly grounded.

Please take the following steps:

- Plug one end of the power cable into the power socket of the router, and plug the other end into the AC power supply outlet.
- Check whether the power LED on the front panel of the router lights up or not. The LED indicator will light up if the power supply is properly connected.

3.5 Connecting the External Port Cables

Step 1: Connect one end of the RJ45 connector to the Ethernet interface of the device board, and the other end to the NMS or a control terminal.

Step 2: Insert the twisted pair with the RJ45 port into the appropriate interface according to the identification on the panel of the module. Distinguish the crossover cable and straight-through cable.

3.6 Installation Verification

Verifying the Cabinet

- Verify if the external power supply matches the distribution panel of the cabinet.
- After equipment is installed, verify if the front/back cabinet doors can be closed.
- Verify that the cabinet has been fastened completely, and does not move or tilt.

- Verify that the equipment has been installed in the cabinet, and all the cables have been fastened to the cabinet.

Verifying the Cables

- Verify that the fibers and twisted pairs match the ports.
- Verify that the cables have been bound properly.

4 System Debugging

4.1 Establishing the Debugging Environment

Establishing the Debugging Environment

Connect the PC to the LAN port of the router, and configure the PC to obtain an IP address automatically.

Or connect the cable of AP to the LAN port of the router. After the AP is powered on, it will broadcast the SSID starting with @Ruijie-m. You can connect to the SSID for configuration.

Figure 4-1 Schematic Diagram of the Configuration Environment

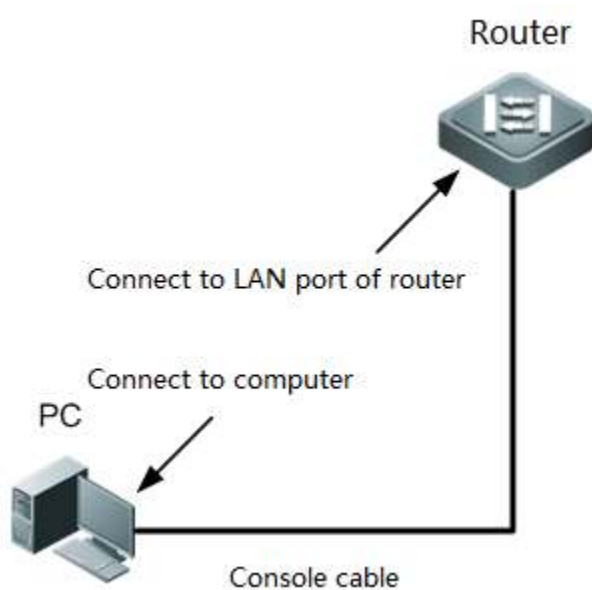

4.2 Startup Check

4.2.1 Checking before the Device is Powered on

- The power cable is correctly connected.
- The power supply voltage complies with the requirement of the router.
- The cable of the PC is properly connected to the LAN port of the router. The parameter settings are correct.

4.2.2 Checking after Program Startup (Recommended)

After power-on, you are recommended to perform the following checks to ensure the normal operation of follow-up configurations.

- Check whether the status of the device indicator is normal.

4.3 Configuring Router

To use the router, more configuration should be made on the device. Please refer to the corresponding command reference and configuration guide.

5 Maintenance and Troubleshooting

5.1 General Troubleshooting Procedure

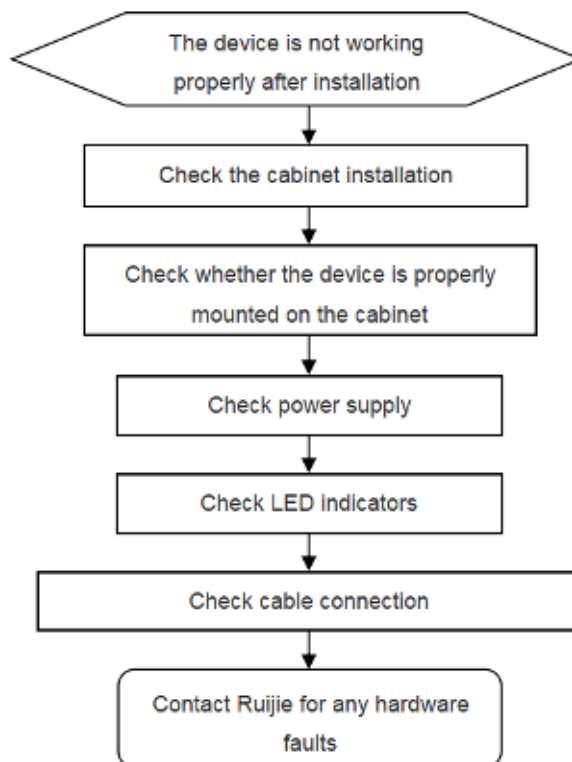

5.2 Troubleshooting Common Faults

Symptom	Possible Causes	Solution
Forgetting the login password	A password is manually configured but it is forgotten.	Press the Reset Button for more than 5 seconds to restore the default password.
The status indicator is not on after the device is started.	The power supply module does not supply power.	Check whether the power socket at the equipment room is normal and whether the power cable of the device is in good contact.
Some PoE ports can not supply power.	Some PoE ports can supply power while other ports can not.	Check whether the ports not supplying power is disabled manually. Check whether the PoE power is sufficient. If not, only the ports with high priority will receive power.

Appendix A Connectors and Connection Media

1000BASE-T/100BASE-TX/10BASE-T Ports

The 1000BASE-T/100BASE-TX/10BASE-T is a port that supports adaptation of three rates, and automatic MDI/MDIX Crossover at these three rates.

The 1000BASE-T complies with IEEE 802.3ab, and uses the cable of 100-ohm Category-5 or Supper Category-5 UTP or STP, which can be up to 100 m.

The 1000BASE-T port uses four pairs of wires for transmission, all of which must be connected. Figure A-1 shows the connections of the twisted pairs used by the 1000BASE-T port.

Figure A-1 Four Twisted Pairs of the 1000BASE-T

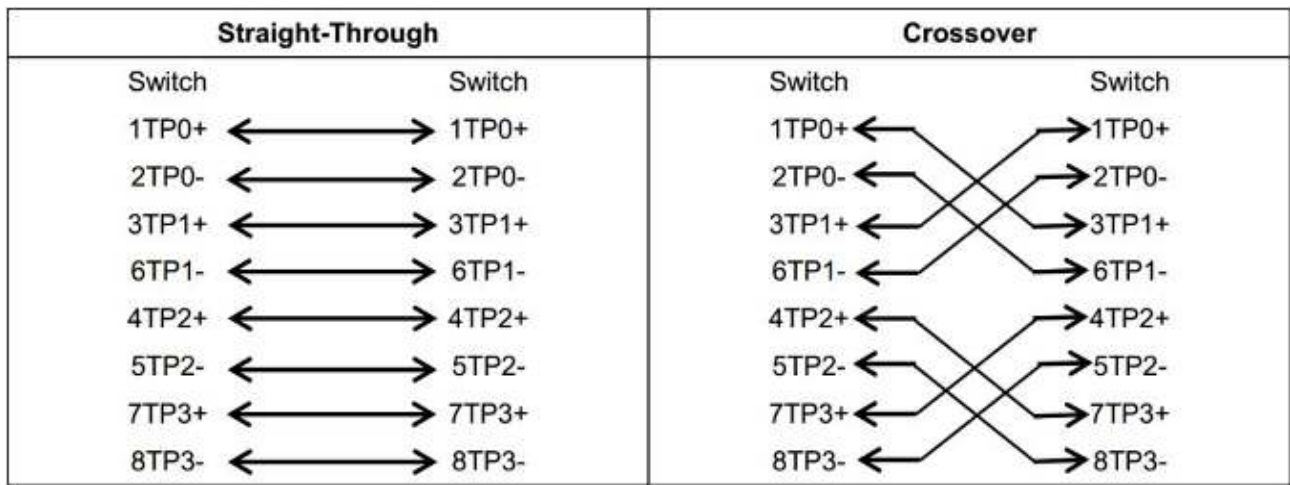

In addition to the above cables, the 100BASE-TX/10BASE-T can also use 100-ohm Category-3, 4, 5 cables for 10 Mbps, and 100-ohm Category-5 cables for 100 Mbps, both of which can be up to 100 m. Figure A-2 shows the pinouts of the 100BASE-TX/10BASE-T.

Figure A-2 Pinouts of the 100BASE-TX/10BASE-T

Pin	Socket	Plug
1	Input Receive Data+	Output Transmit Data+
2	Input Receive Data-	Output Transmit Data-
3	Output Transmit Data+	Input Receive Data+
6	Output Transmit Data-	Input Receive Data-
4,5,7,8	Not used	Not used

Figure A-3 shows the straight-through and crossover cable connections for the 100BASE-TX/10BASE-T.

Figure A-3 Connections of the Twisted Pairs of the 100BASE-TX/10BASE-T

Straight-Through		Crossover	
Switch	Adapter	Switch	Switch
1 IRD+	1 OTD+	1 IRD+	1 IRD+
2 IRD-	2 OTD-	2 IRD-	2 IRD-
3 OTD+	3 IRD+	3 OTD+	3 OTD+
6 OTD-	6 IRD-	6 OTD-	6 OTD-

Optical Fiber Connection

For the optical fiber ports, select single-mode or multiple-mode optical fibers for connection according to the fiber module connected. The connection schematic diagram is shown in Figure A-4:

Figure A-4 Optical Fiber Connections

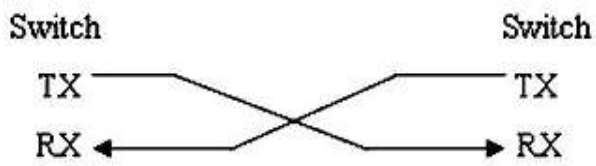

Appendix B: Cabling Recommendations in Installation

When the device is installed in standard 19-inch cabinets, the cables are tied in the binding rack on the cabinet by the cabling rack, and top cabling or bottom cabling is adopted according to the actual situation in the equipment room. All cable connectors should be placed at the bottom of the cabinet in an orderly manner instead of outside the cabinet easy to touch. Power cables are routed beside the cabinet, and top cabling or bottom cabling is adopted according to the actual situation in the equipment room, such as the position of the DC power distribution box, AC socket, or lightning protection box.

Requirement for the minimum cable bend radius

- The bend radius of a power cord, communication cable, and flat cable should be greater than five times their respective diameters. The bend radius of these cables that often bend or suffer removal/insertion should be greater than seven times their respective diameters.
- The bend radius of a common coaxial cable should be greater than seven times its diameter. The bend radius of this type of cables that often bend or suffer removal/insertion should be greater than 10 times its diameter.
- The bend radius of a high-speed cable (SFP cable, for example) should be greater than five times its diameter. The bend radius of this type of cables that often bend or suffer removal/insertion should be greater than 10 times its diameter.

Requirement for the minimum fiber bend radius

- The diameter of a fiber tray to hold fibers cannot be less than 25 times the diameter of the fiber.
- When moving an optical fiber, the bend radius of the fiber should be equal to or greater than 20 times the diameter of the fiber.
- During cabling of an optical fiber, the bend radius of the fiber should be equal to or greater than 10 times the diameter of the fiber.

Precautions for Bundling up Cables

- Before bundling cables, correctly mark labels and stick the labels to cables where appropriate.
- Cables should be neatly and properly bundled, as shown in Figure D-1.

Figure B-1 Bundling Up Cables (1)

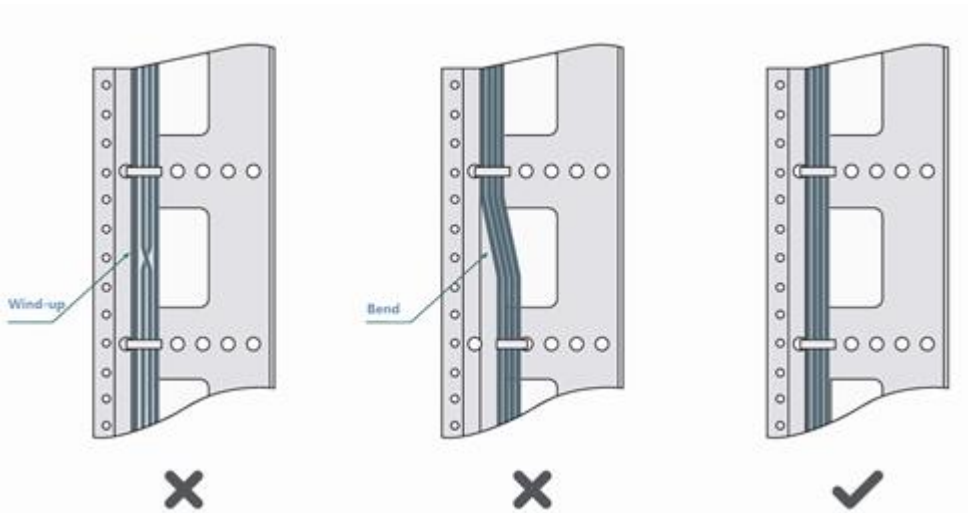

- Cables of different types (such as power cords, signal cables, and grounding cables) should be separated in cabling and bundling. When they are close, crossover cabling can be adopted. In the case of parallel cabling, power cords and signal cables should maintain a space equal to or greater than 30 mm.
- The binding rack and cabling slot inside and outside the cabinet should be smooth, without sharp corners.
- The metal hole traversed by cables should have a smooth and fully rounding surface or an insulated lining.
- Proper buckles should be selected to bundle up cables. It is forbidden to connect two or more buckles to bundle up cables.
- After bundling up cables with buckles, you should cut off the remaining part. The cut should be smooth and trim, without sharp corners, as shown in Figure D-2.

Figure B-2 Bundling Up Cables (2)

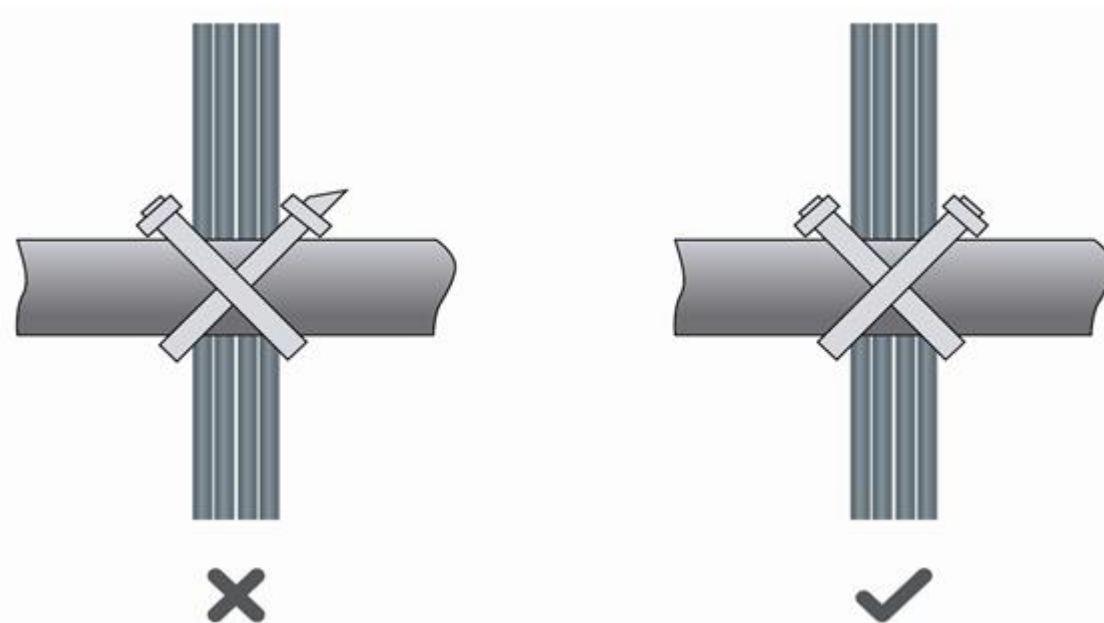

- When cables need to bend, you should first bundle them up. However, the buckle cannot be bundled within the bend area. Otherwise, significant stress may be generated in cables, breaking cable cores. As shown in Figure D-3.

Figure B-3 Bundling Up Cables (3)

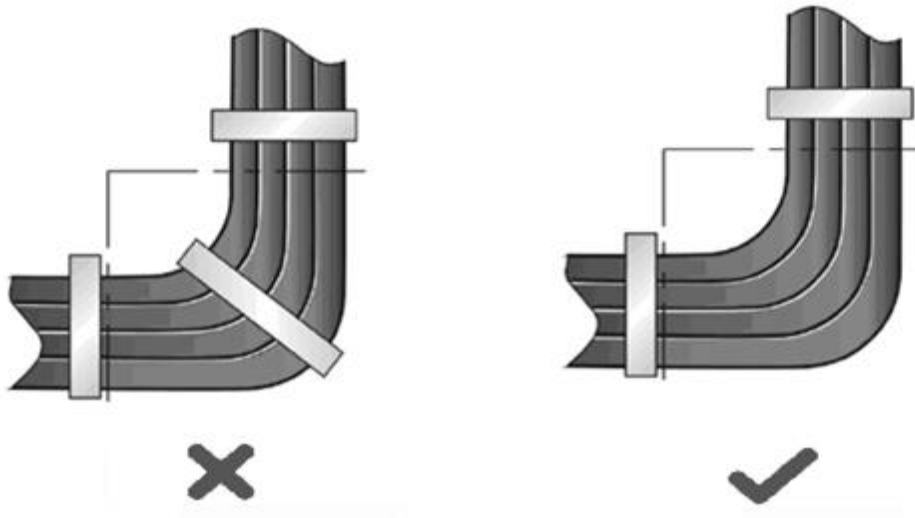

- Cables not to be assembled or remaining parts of cables should be folded and placed in a proper position of the cabinet or cabling slot. The proper position indicates a position that will not affect device running or cause device damage or cable damage during commissioning.
- The power cords cannot be bundled on the guide rails of moving parts.
- The power cables connecting moving parts such as door grounding wires should be reserved with some access after assembled. When the moving part reaches the installation position, the remaining part should not touch heat sources, sharp corners, or sharp edges. If heat sources cannot be avoided, high-temperature cables should be used.
- When using screw threads to fasten cable terminals, the bolt or screw must be tightly fastened, and anti-loosening measures should be taken, as shown in Figure D-4.

Figure B-4 Cable Fastening

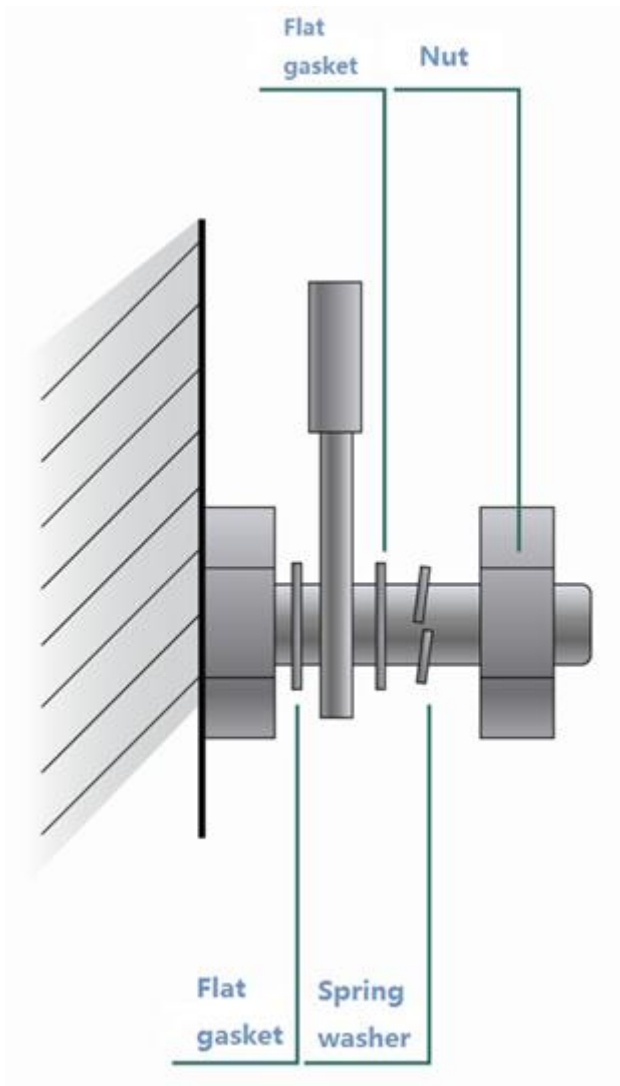

- The hard power cable should be fastened by the terminal connection area to prevent stress.
- Do not use self-tapping screws to fasten terminals.
- Power cables of the same type and in the same cabling direction should be bundled up into cable bunches, with cables in cable bunches clean and straight.
- Binding by using buckles should be performed according to Table B-1.

Cable Bunch Diameter (mm)	Binding Space (mm)
10	80-150
10-30	150-200
30	200-300

- No knot is allowed in cabling or bundling.
- For solder-less terminal blocks (such as air switches) of the cold pressing terminal type, the metal part of the cold pressing terminal should not be exposed outside the terminal block when assemble