



## INTELLIGENT SERIES

*GI-2408T / GI-3406T / GI-2410TM / GI-3407TM Series*

---

**4" Industrial Thermal Transfer Barcode Printer**

# USER'S MANUAL

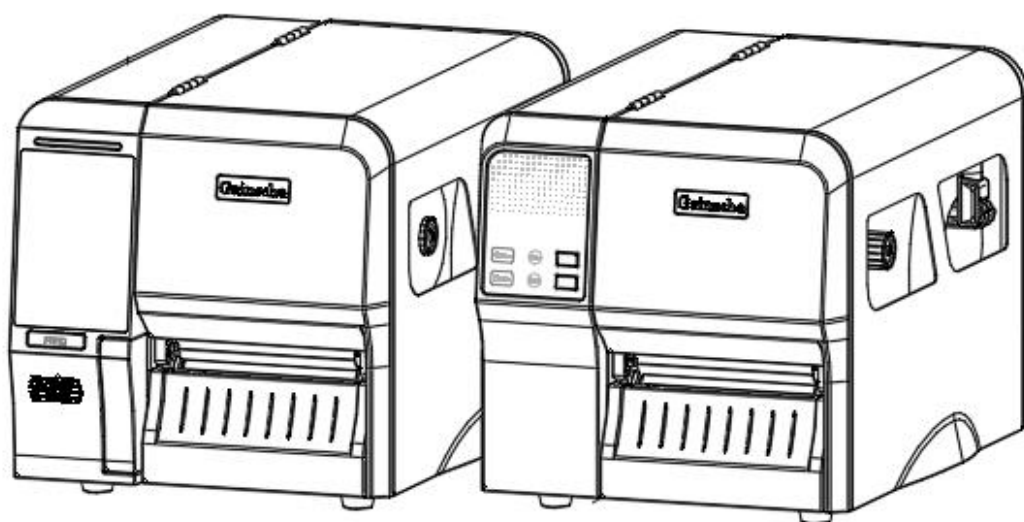

# Agency Compliance and Approvals



EN 55032, Class A  
EN 55024

This is a class A product. In a domestic environment this product may cause radio interference in which case the user may be required to take adequate measures.



FCC part 15B, Class A

This equipment has been tested and found to comply with the limits for a Class A digital device, pursuant to Part 15 of the FCC Rules. These limits are designed to provide reasonable protection against harmful interference when the equipment is operated in a commercial environment. This equipment generates, uses, and can radiate radio frequency energy and, if not installed and used in accordance with the manufacturer's instruction manual, may cause harmful interference with radio communications. Operation of this equipment in a residential area is likely to cause harmful interference, in which case you will be required to correct the interference at your own expense.

## Environmental protection



Do not dispose of this product in an unsorted public trash can. You should recycle this product according to local regulations. For more information, please see our website:

website : <http://www.gainscha.com.tw>

# Contents

---

1. Introduction.....	4
1.1 Product Introduction.....	4
1.2 Product Features.....	6
1.2.1 Printer Standard Features.....	6
1.2.2 Printer Optional Features.....	8
2. Operations Overview.....	9
2.1 Unpacking and Inspection.....	9
2.2 Printer Overview.....	10
2.2.1 Front View.....	10
2.2.2 Interior View.....	11
2.2.3 Front View.....	12
2.2.4 Rear view.....	17
3. Setup.....	18
3.1 Setting up the Printer.....	18

3.2 Install Printer Driver (all series) .....	19
3.3 Loading the Ribbon.....	22
3.3.1 Loading the Ribbon.....	22
3.3.2 Ribbon loading path.....	23
3.4 Loading the Media.....	24
3.4.1 Loading the Media.....	24
3.4.2 Media loading path.....	25
3.5 Loading the Peeler (Dealer options).....	26
3.5.1 Loading the Media.....	29
4. Adjustment Knob.....	30
4.1 Print Head Pressure Adjustment Knob.....	30
4.2 Vertical position adjustment knob on the right side of the print head.....	31
4.3 Mechanism Fine Adjustment to Avoid Ribbon Wrinkles.....	32
5. Button Functions.....	35
5.1 Regular Button Functions.....	35
5.2 Power-on Utilities.....	36

6. PrinterUtility .....	37
6.1 Start the PrinterUtility .....	37
6.2 Printer Function .....	38
7. LCD Menu Function for GI-2410TM and GI- 3407TM Series.....	39
7.1 Enter the Menu.....	39
7.2 Menu Overview .....	40
8. Troubleshooting .....	44
8.1 Common Problems.....	44
9. Maintenance.....	46
10. Revise History.....	47

# 1. Introduction

---

## 1.1 Product Introduction

Thank you very much for purchasing Gainscha bar code label printer.

The new high-performance GI Series was designed to deliver the cleanest and high quality barcodes. It features a die-cast print mechanism housed in a very strong yet lightweight cabinet. This new design results in a more durable printer that is suited for your most heavy-duty demand cycles.

There have T and TM Series, and includes 203 dpi / 300 dpi series, which can be applied to printing very small 2D barcodes, graphics, fine print and other ultrahigh-resolution images.

The T Series printers are loaded with standard features including four color lights and two menu buttons; The TM Series printers are loaded with standard features including a 4.3" color touch display and one menu button, support for 450 meter long ribbons, 8" OD media rolls, built-in Ethernet, 1 or 3 USB hosts for keyboard and scanner connections, USB 2.0, serial interfaces, optional internal Bluetooth module and WIFI module.

Fonts and bar codes can be printed in four directions. This model has a built-in high-quality and efficient True Type Font engine. With a flexible firmware design, users can also download True Type Font from the computer to the printer's memory. In addition to scalable fonts, eight

different sizes of alphanumeric maps (bitmap font) are provided.

To print label formats, please refer to the instructions provided with your labeling software, available on Gainscha website <http://www.gainscha.com.tw> °

- Applications
  - Manufacturing & Warehousing
    - Work in Progress
    - Item Labels
    - Instruction labels
    - Agency labels
    - Compliance labels
    - Logistics management labels
    - Electronics labels
    - Industrial-duty Printing
  - Healthcare
    - Patient Identification
    - Pharmacy
    - Specimen Identification
  - Retail Marking
    - Price tags
    - Shelf labels
    - Jewelry tags
    - Asset management labels
    - Care labels
  - Parcel Post
    - Shipping/ Receiving Labels
  - Small Office/ Home Office

## 1.2 Product Features

### 1.2.1 Printer Standard Features

MODEL	GI-2408T	GI-3406T	GI-2410TM	GI-3407TM
Level	Economic	Economic	Empower	Empower
Resolution	8dots/mm (203DPI)	12dots/mm (300DPI)	8dots/mm (203DPI)	12dots/mm (300DPI)
Printing Method	Thermal Transfer & Direct Thermal			
Max. print speed	203mm(8")/ second	152mm(6")/ second	254mm(10")/ second	117.8mm(7")/ second
Max. print width	104 mm (4.09")	106.7 mm (4.2")	108 mm (4.25")	104 mm (4.09")
Max. print length	2,286mm (90")	1,016mm (40")	2,286mm (90")	1,016mm (40")
CPU 规格	400 MHZ, 32 bits, ARM9			
Memory RAM	128 MB SDRAM		256 MB SDRAM	
Memory ROM	128 MB Flash Memory		256 MB Flash Memory	
Interface	<ul style="list-style-type: none"> <li>• USB 2.0 High Speed 480Mbps</li> <li>• USB Host 2.0, for scanner or PC keyboard</li> <li>• RS-232</li> </ul>		<ul style="list-style-type: none"> <li>• Internal Ethernet 10/100Mbps</li> <li>• Internal Bluetooth 4.0 (factory option)</li> <li>• Internal WiFi (factory option)</li> </ul>	
Real Time Clock	Standard			
Buzzer	Standard			
Dealer options	<ul style="list-style-type: none"> <li>• Guillotine cutter (full cut and partial cut)</li> </ul>		<ul style="list-style-type: none"> <li>• Peeler</li> </ul>	
Sensors	<ul style="list-style-type: none"> <li>• Gap transmissive sensor (position adjustable)</li> <li>• Black mark reflective sensor (position adjustable)</li> <li>• Head open sensor</li> <li>• Ribbon out sensor</li> </ul>		<ul style="list-style-type: none"> <li>• Ribbon end sensor</li> <li>• Label end sensor</li> <li>• Label begin sensor</li> </ul>	
Power	Internal universal switching power supply			



	Input: AC 90-240V, 1.5A, 50-60Hz, Output: DC 24V, 5A, 120W			
<b>User Interface</b>	<ul style="list-style-type: none"> <li>1 power switch</li> <li>2 buttons (Feed &amp; Pause)</li> <li>4 LEDs (Online, Error, Ribbon, Communication status)</li> </ul>	<ul style="list-style-type: none"> <li>Capacitive Touch Screen, TFT LCD 4.3" 16 bits Color, 272 x 480 pixels, with back lights</li> <li>1 power switch, 1 buttons (Feed), 3 LEDs (Online, Error, Ribbon status)</li> </ul>		
<b>Internal fonts</b>	<ul style="list-style-type: none"> <li>8 alpha-numeric bitmap fonts</li> <li>True type font engine (need download scalable font file)</li> </ul>			
<b>1D Barcode</b>	Code 11, Code 39, Code 93, Code 128 (subsets A, B, C), UPC-A, UPC-E, UCC-128, Codabar, EAN/JAN-8, EAN/JAN-13, Interleaved 2 of 5, ITF14, MSI Plessey, PostCode, Telepen			
<b>2D Barcode</b>	QR Code, Micro QR Code, PDF417, Micro PDF417, MaxiCode, Aztec Code, Data Matrix			
<b>Rotation</b>	Font and barcode support 0, 90, 180, 270 degree			
<b>Printer language</b>	Compatible to TSPL, EPL, ZPL, ZPL II, DPL			
<b>Ribbon</b>	450 M long, max. OD 105 mm, 1" core (ink coated outside)			
<b>Ribbon width</b>	Max.115mm (4.5")			
<b>Media type</b>	Continuous, die-cut, black mark, fan-fold (outside wound)			
<b>Media width</b>	20~ 120 mm (0.78" ~ 4.72")			
<b>Media thickness</b>	0.06~0.254mm (2.36 ~ 10 mil)			
<b>Media core diameter</b>	25.4 mm ~ 76.2 mm (1" ~ 3")			
<b>Label roll capacity</b>	203 mm (8") OD			
<b>Label length</b>	5 ~2,286 mm (0.2" ~ 90")	5 ~1,016 mm (0.2" ~40")	5 ~2,286 mm (0.2" ~ 90")	5 ~1,016 mm (0.2" ~40")
<b>Physical dimension</b>	425mm(L)*255mm(W)*265mm(H)			
<b>Net Weight</b>	9.65kg			

<b>Enclosure</b>	Die-cast based print mechanism/Metal cover with large clear media view window
<b>Safety regulation</b>	FCC Class A, CE Class A, CCC, BIS, CB
<b>Environment condition</b>	Operation: 5 ~ 40°C, 25 ~ 85% non-condensing Storage: -40 ~ 60°C, 10 ~ 90% non-condensing
<b>Environmental concern</b>	Comply with RoHS, REACH, WEEE
<b>Accessories</b>	<ul style="list-style-type: none"> <li>• Windows labeling software CD</li> <li>• Quick start guide</li> <li>• USB cable</li> <li>• Power cord</li> </ul>

### 1.2.2 Printer Optional Features

<b>Product option feature</b>	<b>User options</b>	<b>Dealer options</b>	<b>Factory options</b>
Internal Bluetooth module in front panel		○	○
Internal WIFI module in front panel		○	○
Peel-off module assembly		○	○
Textile Care Cutter			○

NOTE : Except for the linerless cutter, all regular/heavy duty/care label cutters DO NOT cut on media with glue.

## 2. Operations Overview

---

### 2.1 Unpacking and Inspection

This printer has been specially packaged to withstand damage during shipping. Please carefully inspect the packaging and printer upon receiving the bar code printer. Please retain the packaging materials in case you need to reship the printer.

Unpacking the printer, the following items are included in the carton.

- One printer unit
- One quick installation guide
- One power cord
- One Windows labeling software/Windows driver CD disk
- One USB interface cable
- One pair of one core ribbon samples
- One core coated art paper roll

If any parts are missing, please contact the Customer Service Department of your purchased reseller or distributor.

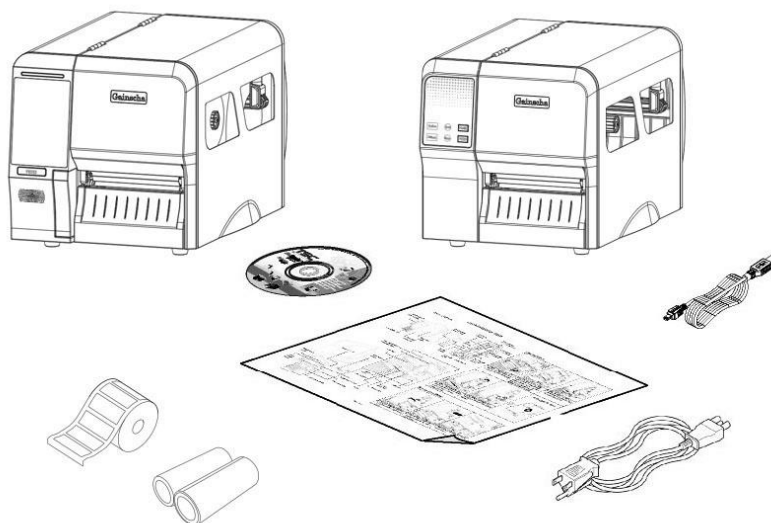

## 2.2 Printer Overview

### 2.2.1 Front View

#### GI-2408T and GI-3406T Series



#### GI-2410TM and GI- 3407TM Series



## 2.2.2 Interior View

### All Series

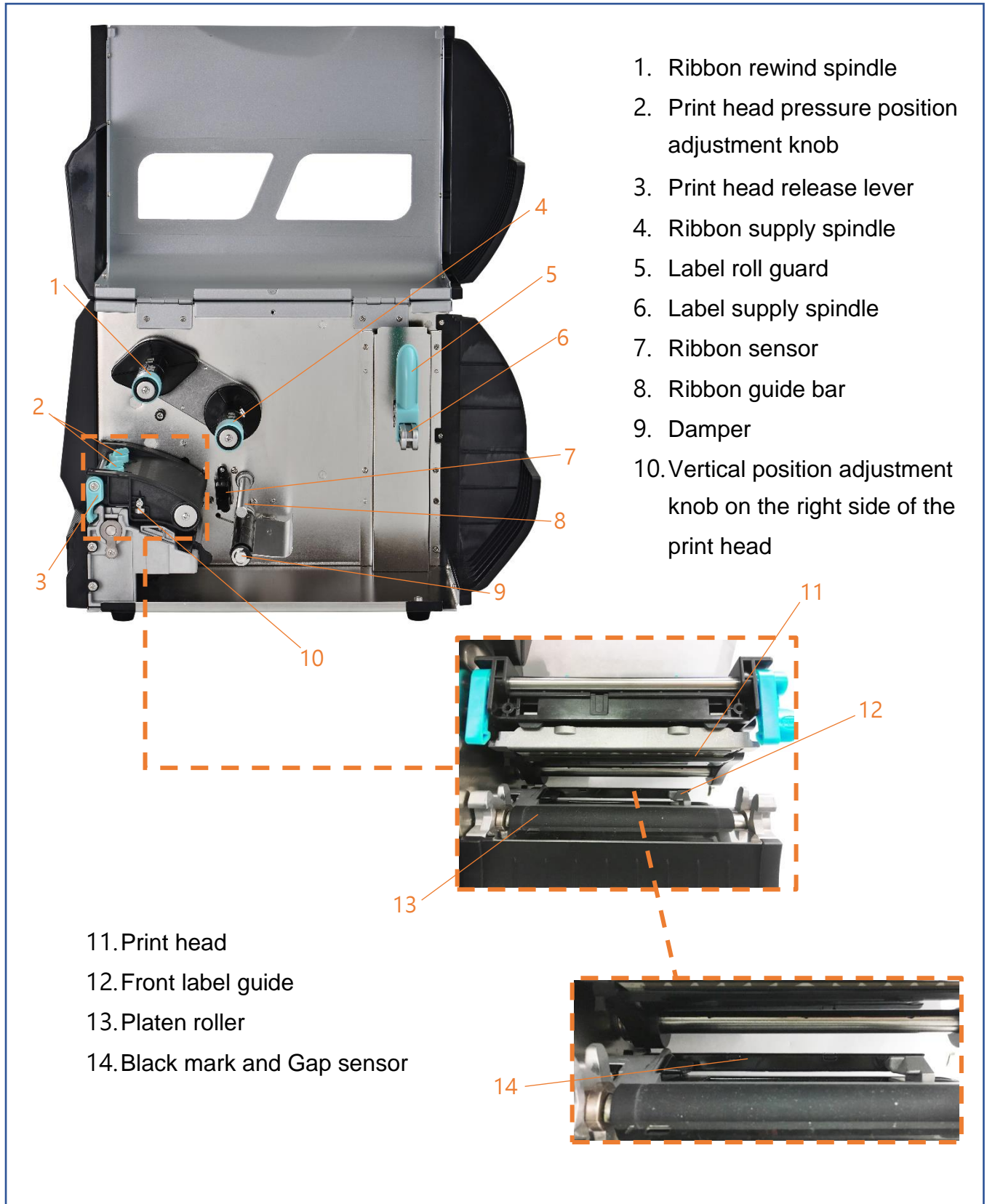

### 2.2.3 Front View

GI-2408T and GI-3406T Series(Contains LED indicator's function introduction)

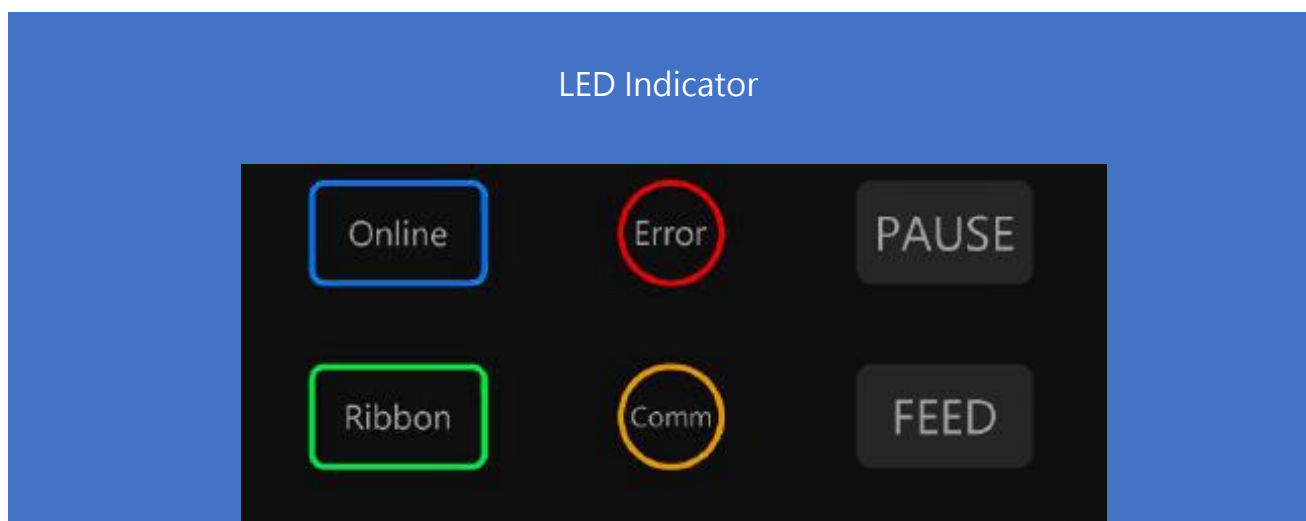

Event	Description
Thermal transfer mode ready	Blue(ONLINE) and Green(RIBBON) solid, and the device is ready to use.

Direct thermal mode ready	Blue(ONLINE) solid, and the device is ready to use.
Open cover	When the cover is open, a beep sound will be made, and Blue(ONLINE), Red (ERROR), and Green(RIBBON) will flash.
PAUSE	Press the PAUSE button. When the Blue(ONLINE) flash, the printer will pause.
FEED	Press the FEED button to print as per demand, Blue(ONLINE) will flash.
Out of paper	When out of paper, a beep sound will be made, and Red(ERROR) flash
Out of ribbon	When out of ribbon, a beep sound will be made, and Red(ERROR) solid · Green(RIBBON) flash
Label gap/black mark error	When label gap/black can't be found, a beep sound will be made, and Red(ERROR) Blue(ONLINE) flash
Cutter error	When cutter can't be found, a beep sound will be made, and Blue(ONLINE) · Red(ERROR) Both flash alternately, flash with Green(RIBBON)
Print head overheated	When print head overheated ,a beep sound will be made, and Blue(ONLINE)and Red(ERROP) alternately flash

Other errors	When other errors ,a beep sound will be made, and Red(ERROR) and Green(RIBBON) alternately flash
Ethernet ready	When the RJ45 network cable is plugged in and the connection is normal, the Orange(COMM) flash
WIFI ready	When the WIFI's AP or STA mode is connected, the orange(COMM) solid
Ethernet+WIFI ready	When the RJ45 network cable is plugged in, and the connection is normal, and the WIFI's AP or STA mode is connected, the orange (COMM) will be solid for 2 seconds and the orange(COMM) flash.



GI-2410TM and GI- 3407TM Series (Contains LCD monitor operation introduction)



- 1. LED Indicator (ONLINE)
- 2. FEED or PAUSE BUTTON



time/date

Printer model





FE Ver: printer firmware version  
 Emulation: Simulation instruction category  
 ETH IP: Ethernet IP address  
 WIFI IP: Wi-Fi IP address

Printer status

## Operation buttons

Buttons	Function
FEED or PAUSE button <div style="border: 1px solid black; padding: 5px; display: inline-block; margin: 10px 0;">             FEED           </div>	In the ready state, press this button, the machine will spit a sheet of paper, in the printing state, press this button, the machine will stop immediately, in the error state, press this button, the machine will cancel the error state and restore printing function.

## Main page icons

Indicated icon	Indication
	Ethernet is connected
	Wi-Fi device is ready
	Bluetooth device is ready
	USB HID is connected · ex: USB scanner · USB keyboard
	Thermal transfer mode · use ribbon function

## 2.2.4 Rear view

### All series

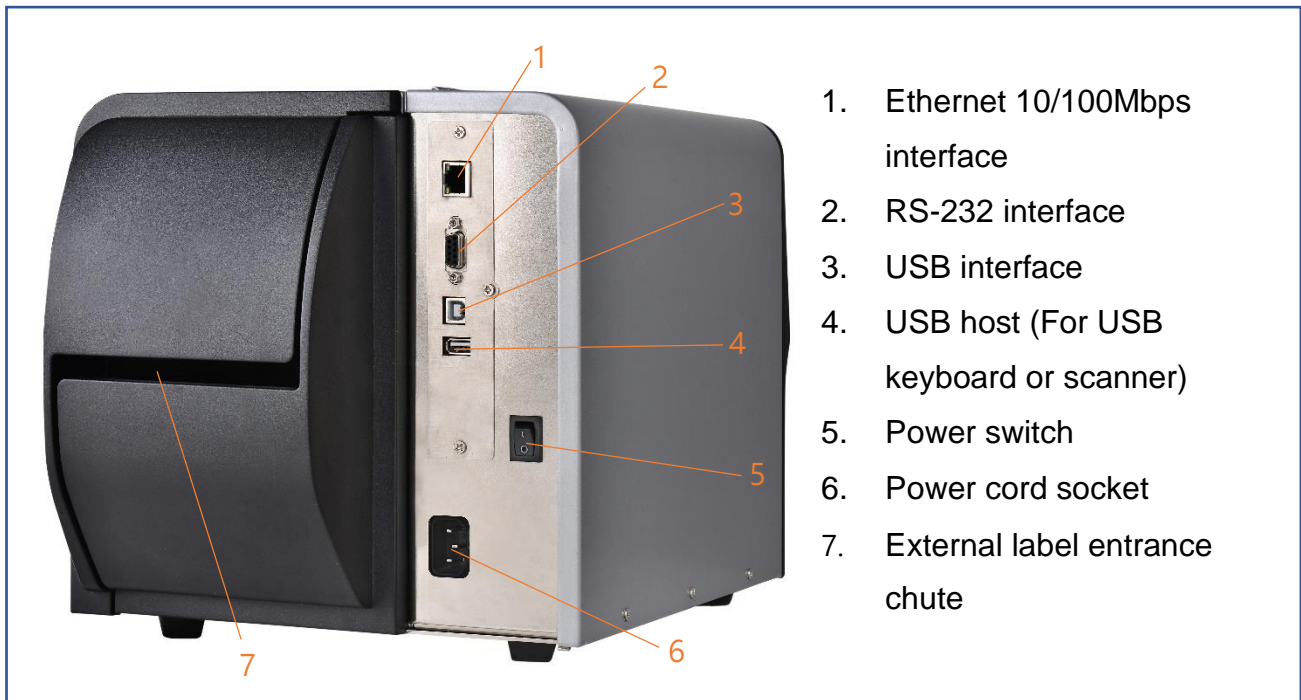

# 3. Setup

---

## 3.1 Setting up the Printer

1. Place the printer on a flat, secure surface.
2. Make sure the power switch is off.
3. Connect the printer to the computer with the provided USB cable.
4. Plug the power cord into the AC power cord socket at the rear of the printer, and then plug the power cord into a properly grounded power outlet.

**NOTE:**

- \* Please switch OFF printer power prior to plugging in the power cord to printer power jack.
- \* The interface picture here is for reference only. Please refer to the product specification for the interfaces availability.

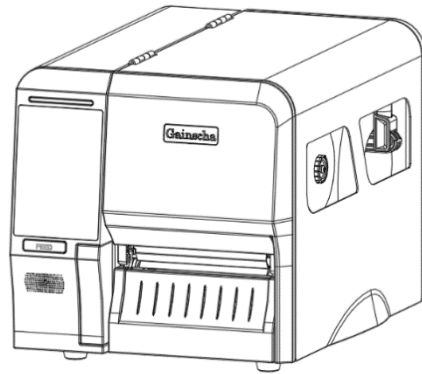
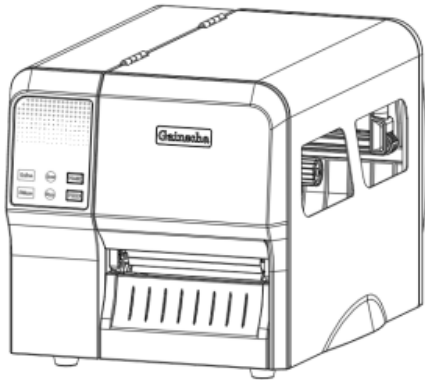

### 3.2 Install Printer Driver (all series)

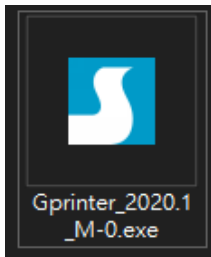

(Recommended to install the printer driver model for 203 dpi, please install GI-2408T, 300 dpi, please install GI-3406T)

<p>1. Read the license agreement, click [I accept the terms in license agreement], and click [Next].</p>	<p>2. Select a installation directory and click [Next].</p>

3. Click [Finish].

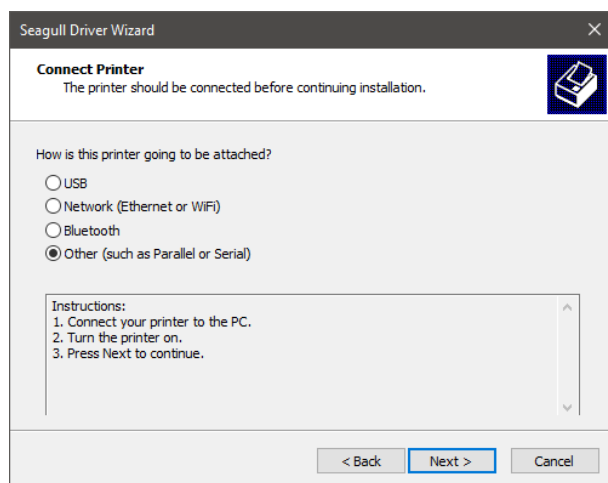

4. Go to installation process, please click [Install Printer Driver], and then click [Next].

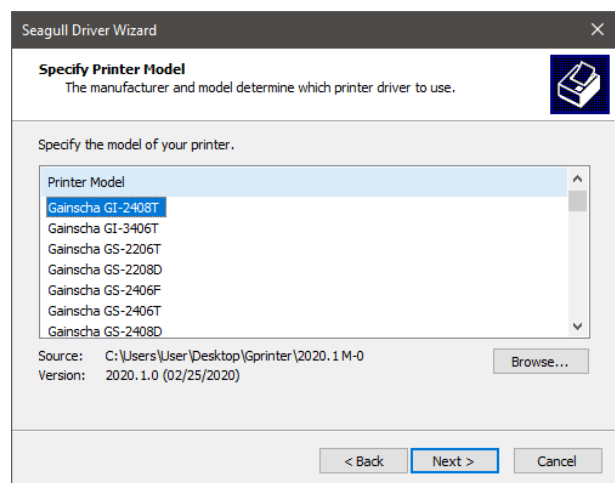

5. Click [Other] and click [Next].

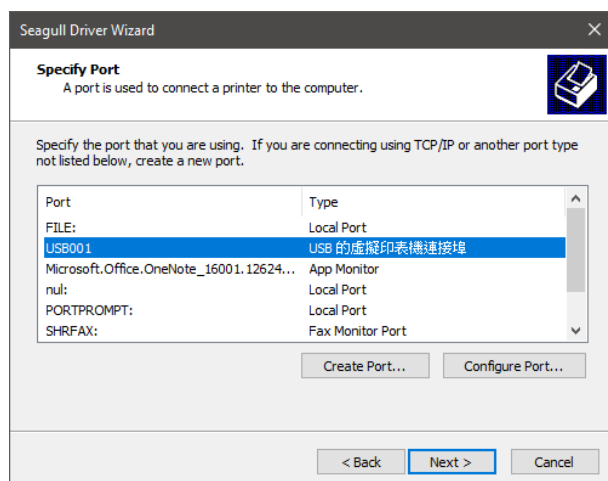

6. Select printer model name, click to install and click [Next].

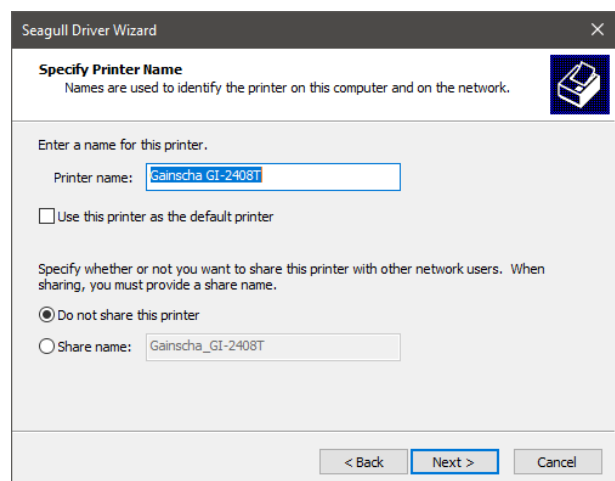

7. Please use a USB cable to connect the printer to the computer, click the corresponding USB interface, and click [Next].

8. Change the printer name as per need, and click [Next].

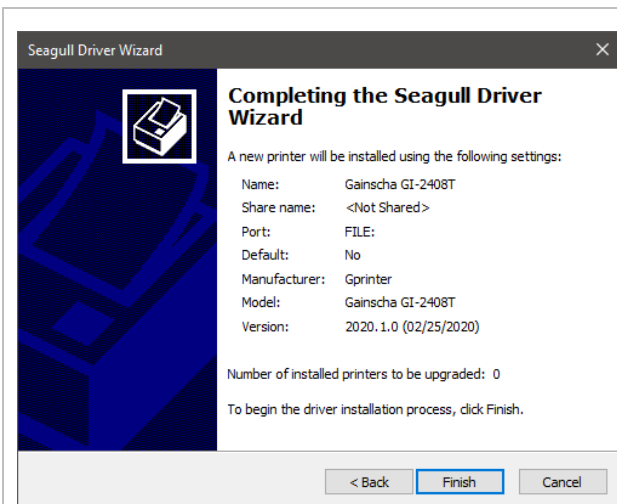

9. Click [Finish].

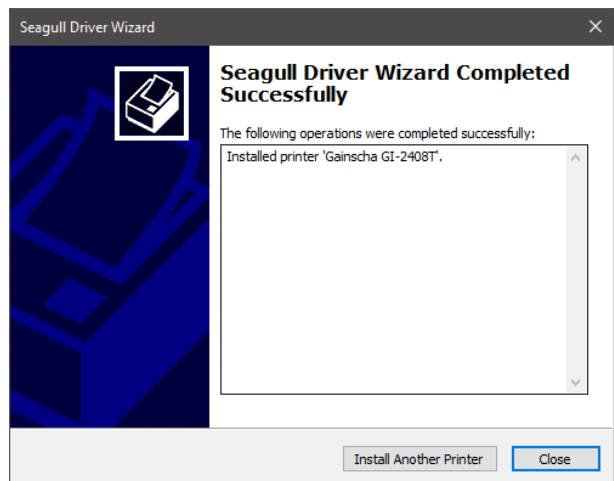

10. The installation is completed, please click [Close].

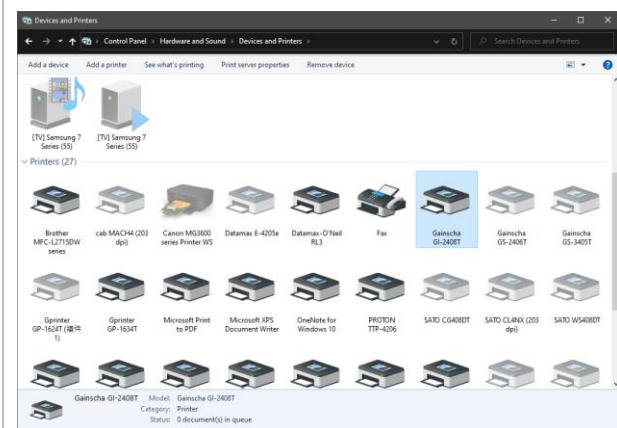

11. Users can check whether the installation is completed through the following ways:

- a. If Windows 10, check from [Windows Settings] → [Devices] → [Printers and Scanners].
- b. Check from [Control Panel] → [Devices and Printers].

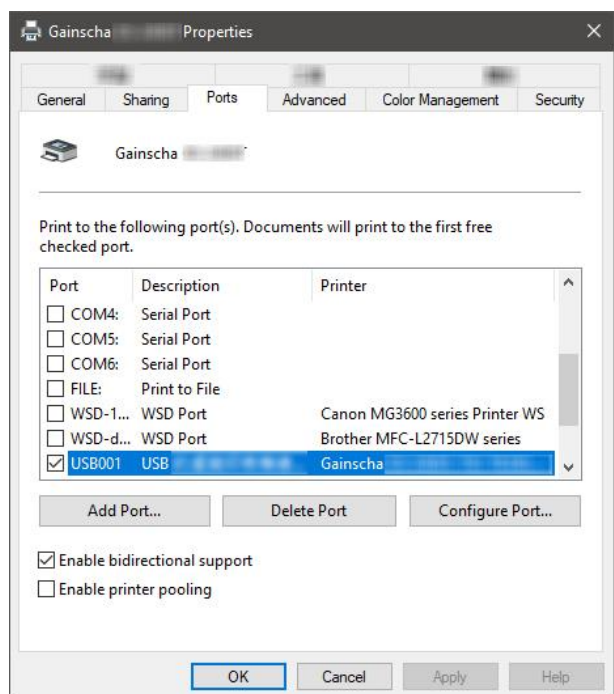

12. Users can change printer interface through the following ways:

- a. In Windows 10, [Windows Settings] → [Printers and Scanners] → [Devices] → select the corresponding printer model → [Management] → [Printer Content] → [Port] to change different USB port / COM port as per need.
- b. From [Control Panel] → [Devices and Printers] → select the corresponding printer model → right-click → [Printer Content] → [Port] to modify it.



## 3.3 Loading the Ribbon

### 3.3.1 Loading the Ribbon

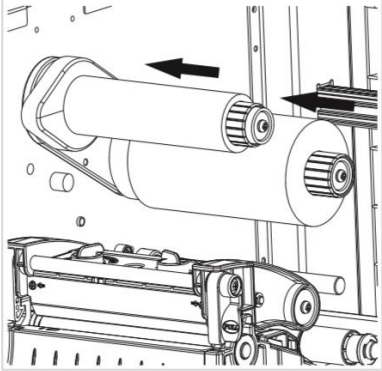
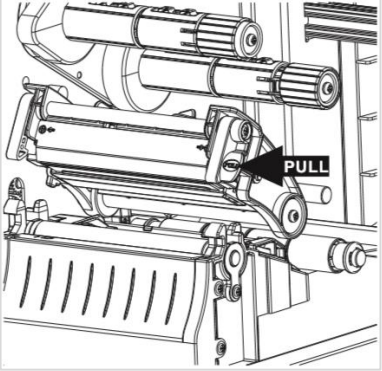
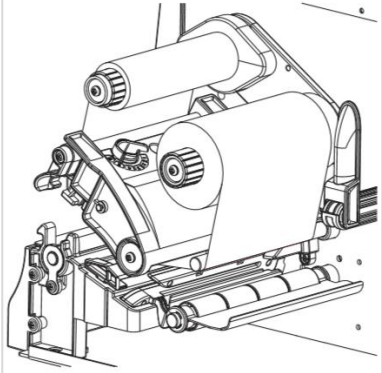
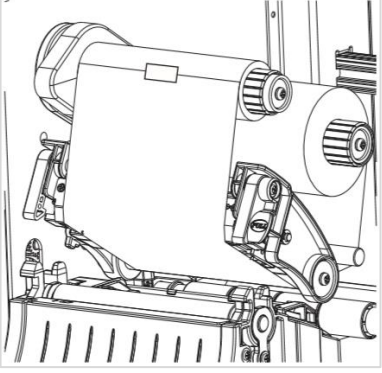
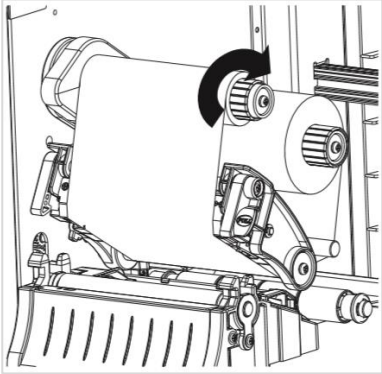
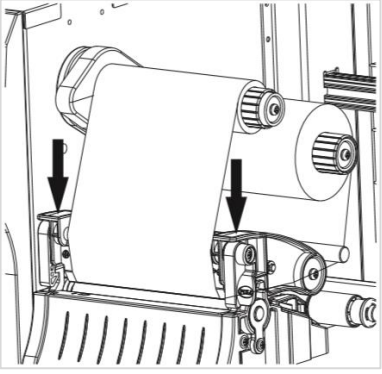
	
<p>1. Lift the printer cover handle, and install the ribbon and empty ribbon roll on the ribbon supply spindle and ribbon rewind spindle, respectively.</p>	<p>2. Pull the Print head release lever to open print head mechanism.</p>
	
<p>3. Thread ribbon below the ribbon guide bar through ribbon sensor slot. ( See the "Ribbon Loading Path" illustration below).</p>	<p>4. Fix the smooth and wrinkled front end of the ribbon on the empty ribbon roll.</p>
	
<p>5. Wind the ribbon rewind spindle clockwise roughly 3~5 circles until the ribbon is smooth, properly stretched and wrinkle-free.</p>	<p>6. Close the print head mechanism by pushing down the both sides of the print head release lever.</p>



### 3.3.2 Ribbon loading path

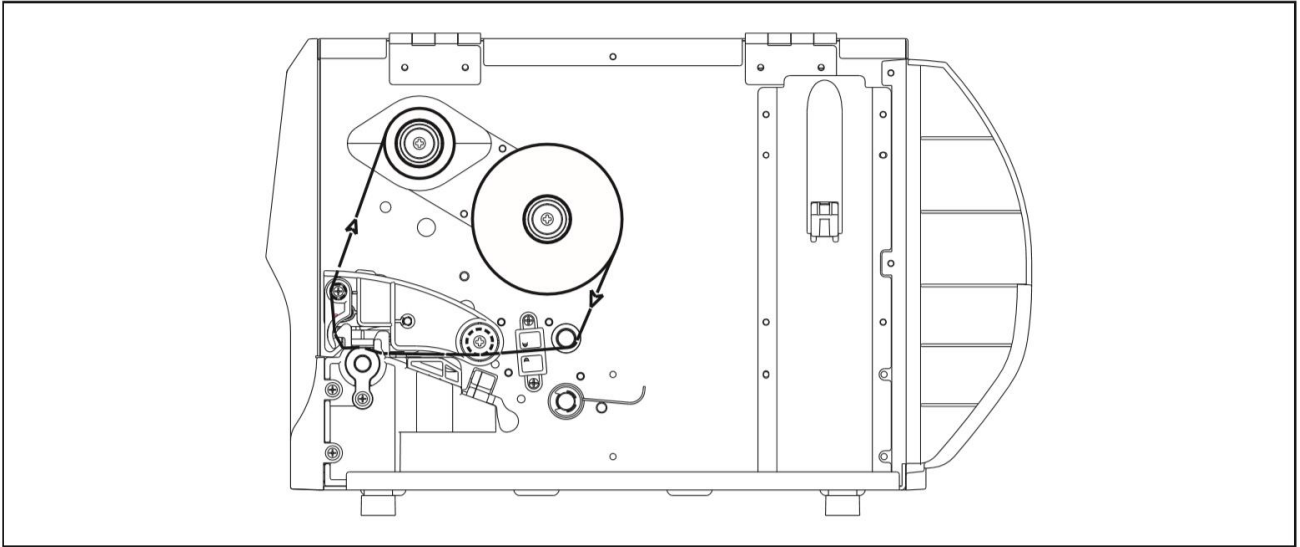

- Model specifications, accessories, parts and programs are mainly based on the actual machine, subject to change without prior notice.

## 3.4 Loading the Media

### 3.4.1 Loading the Media



1. Move the label roll guard horizontally to the end of label spindle, then flip down the label roll guard.

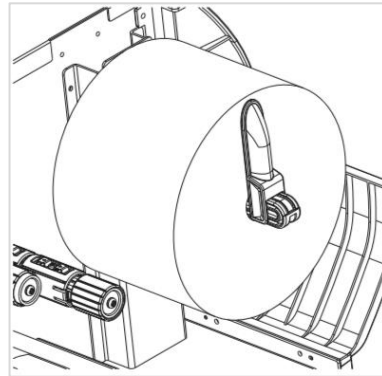

2. Place the media roll on the label supply spindle and use label roll guard to fix it.

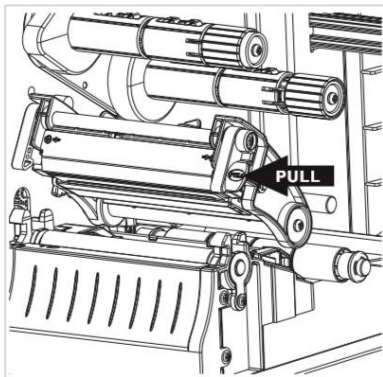

3. Pull the Print head release lever to open print head mechanism.

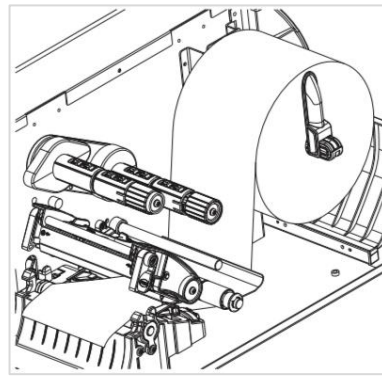

4. Install the label through the media guide bar, damper, media sensor, and label guide to install the media. (See the "Media Loading Path" illustration below).

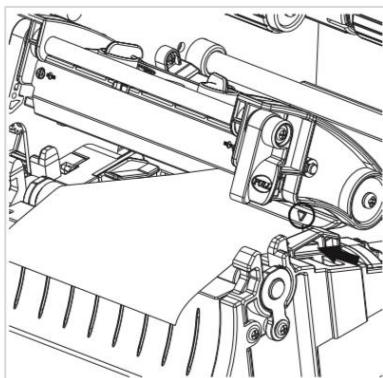

5. Move the media sensor by adjusting the media sensor position adjustment knob, make sure the gap or black mark sensor is at the location where media gap/black mark will pass through for sensing. Adjust the label guide to fix the media position.

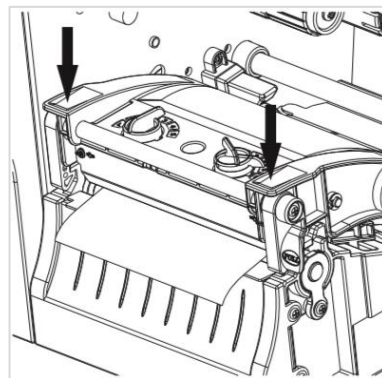

6. Close the print head mechanism on both sides and make sure the latches are engaged securely. Set media sensor type and calibrate the selected sensor.

### 3.4.2 Media loading path

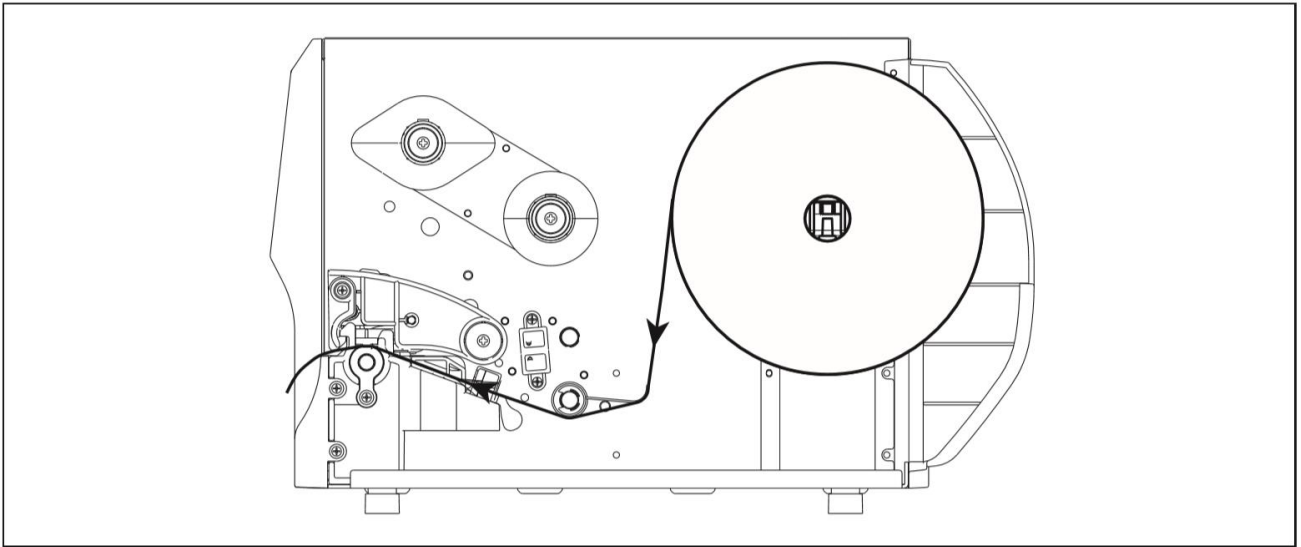

- Model specifications, accessories, parts and programs are mainly based on the actual machine, subject to change without prior notice.

### 3.5 Loading the Peeler (Dealer options)

	<p>Peeler</p>
	<p>1. Open the printer right side cover.</p>



2. Remove the two screws located on the side of the cover.

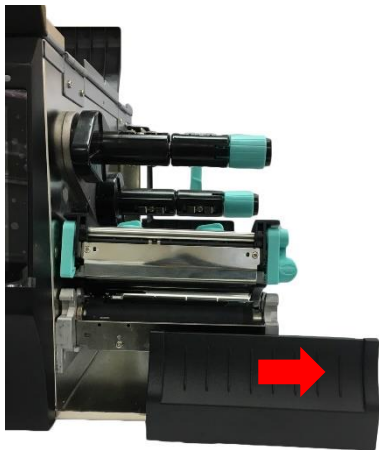

3. Push the cover to the right to remove it.  
4. Please be careful not to break the cover outwards to avoid breaking the groove of the cover.

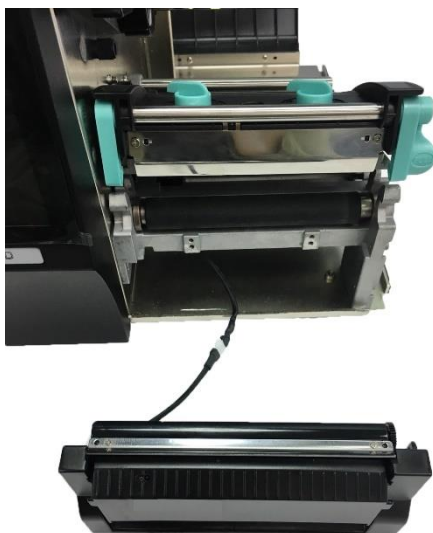

5. After pulling out the wafer 1x3P P2.0 of the printer, connect it to the wafer 1x3P P2.0 of the peeler.



6. After the connection is completed, groove foot on the peeler to the base iron plate near the panel, and then gently push it to the left.

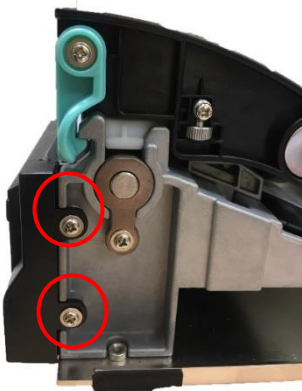

7. Lock the two screws located on the side of the peeler.



8. After the printer right side cover is closed, complete.

### 3.5.1 Loading the Media

	<p>Please pull the two sides of the peeler (as shown by the red circle in the figure), and pull them outward.</p>
	<p>After pulling outward, pass the label under the peeler and then pull it out.</p>
	<p>After pulling out, please push the two sides of the peeler (as shown by the red circle in the figure), and push it inwards. When user hear a click, complete.</p>



## 4. Adjustment Knob

---

### 4.1 Print Head Pressure Adjustment Knob

The print head pressure adjustment knob has 5 levels of adjustment. Press down the adjustment knob and turn the adjustment knob left and right to adjust the print head pressure.

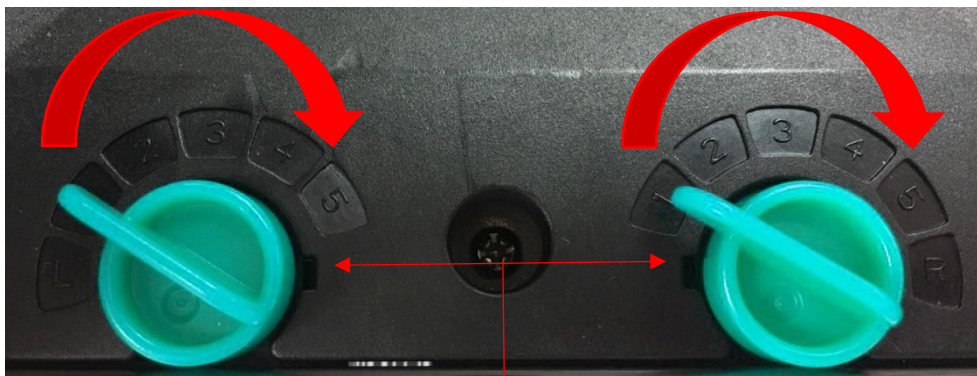

Print Head Pressure Adjustment Knob

Note: For the label width less than 2 inches, please fix the Print head pressure adjustment knob inside the edge of the label as possible (prevent the unnecessary friction between the print head and platen roller).



## 4.2 Vertical position adjustment knob on the right side of the print head

Because the printer's paper alignment is to the left side of mechanism, different media widths require the different pressure to print the label correctly. Therefore, it may require to adjust the vertical position adjustment knob on the right side of the print head and get the best print quality.

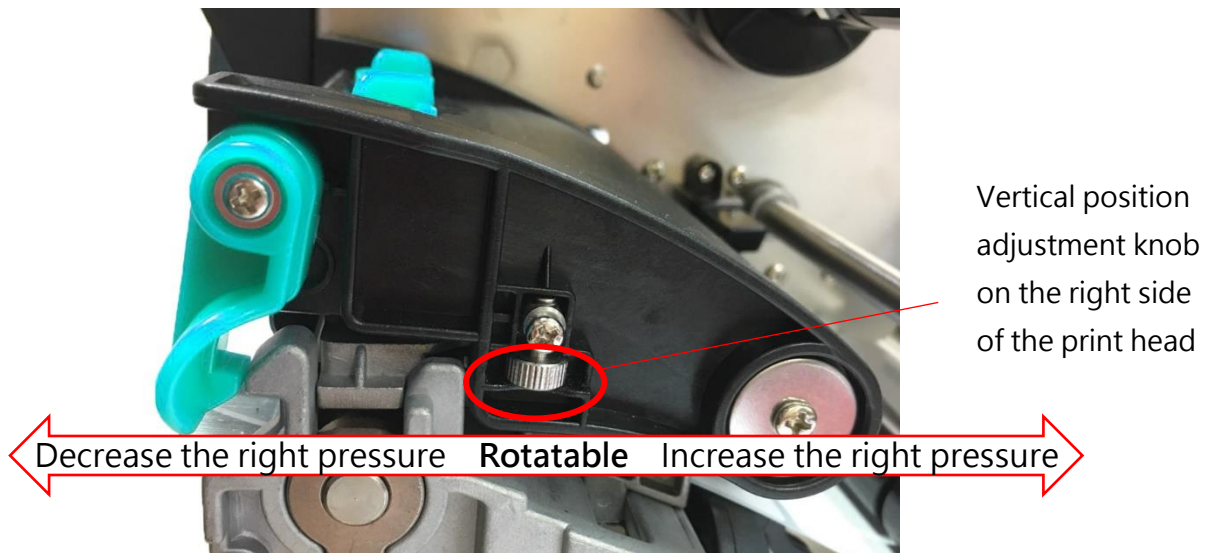

### 4.3 Mechanism Fine Adjustment to Avoid Ribbon Wrinkles

This printer has been fully tested before delivery. There should be no ribbon wrinkle presented on the media for general-purpose printing application. Ribbon wrinkle is related to the media width, thickness, print head pressure balance, ribbon film characteristics, print darkness setting...etc. In case the ribbon wrinkle happens, please follow the instructions below to adjust the printer parts.

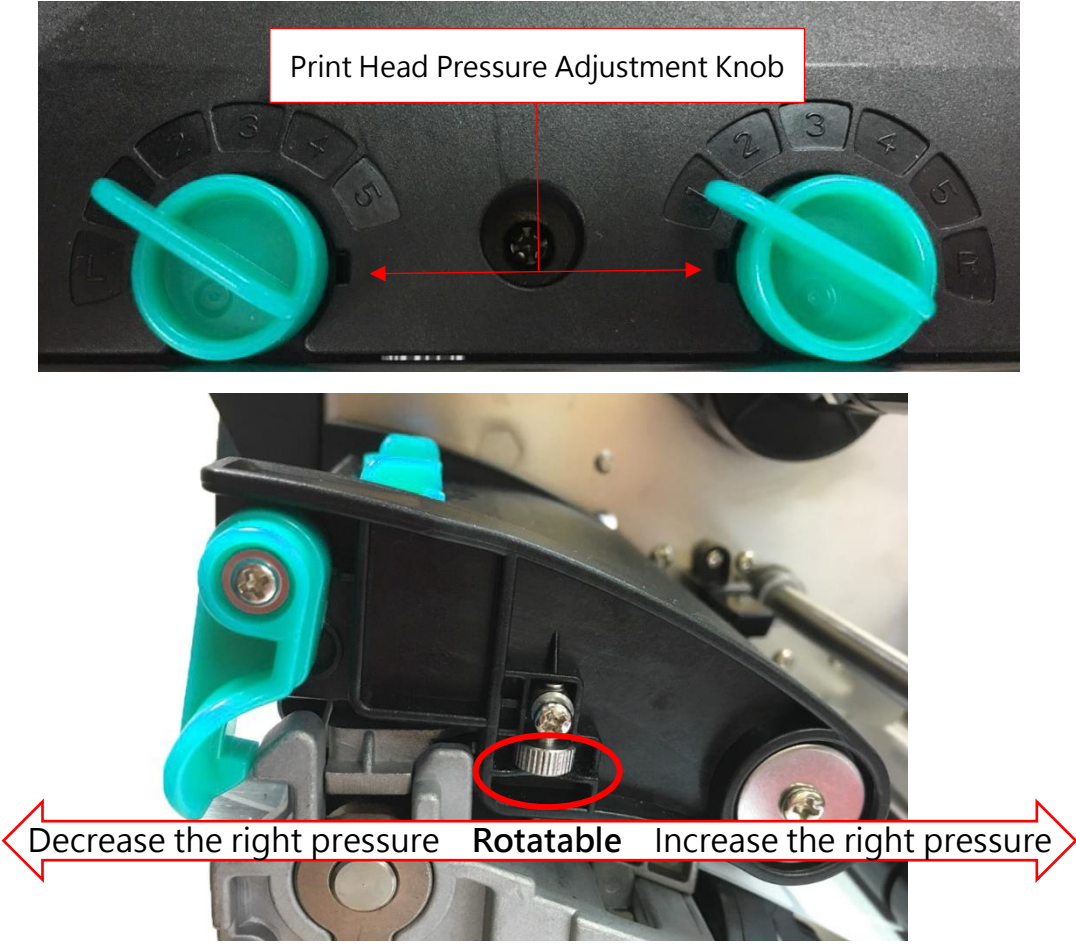
Adjustable Printer Parts	<p>Print Head Pressure Adjustment Knob has 5 positions for adjustment. The vertical position adjustment knob on the right side of the print head can adjust the pressure of the right print head position.</p> 
--------------------------	---

	Vertical position adjustment knob on the right side of the print head	
Symptom and Example	<p>1. Wrinkle happens from label lower left to upper right direction.</p>	<p>2. Wrinkle happens from label lower right to upper left direction.</p>
Wrinkle Example	<div data-bbox="343 461 837 840" data-label="Image"> </div> <p data-bbox="491 846 694 878">Feed direction</p>  <p data-bbox="320 969 837 1193">If the wrinkle on the label starts from the lower left side to upper right side, please do following adjustment.</p> <div data-bbox="328 1243 876 1682" data-label="Image"> </div> <p data-bbox="320 1731 853 1955">1. Please switch the vertical position adjustment knob on the right side of the print head per 1 level and</p>	<div data-bbox="914 461 1409 840" data-label="Image"> </div> <p data-bbox="1062 846 1265 878">Feed direction</p>  <p data-bbox="890 969 1409 1193">If the wrinkle on the label starts from the lower right side to upper left side, please do following adjustment.</p> <div data-bbox="898 1243 1449 1682" data-label="Image"> </div> <p data-bbox="890 1731 1425 1955">1. Please switch the vertical position adjustment knob on the right side of the print head per 1 level and</p>

	<p>print the label again to check if the wrinkle is gone.</p> <p>2. If the ribbon wrinkle still can't improve after switch the vertical position adjustment knob on the right side of the print head, please adjust the print head pressure adjustment knob per 1 level again to check if the wrinkle is gone.</p>	<p>print the label again to check if the wrinkle is gone.</p> <p>2. If the ribbon wrinkle still can't improve after switch the vertical position adjustment knob on the right side of the print head, please adjust the print head pressure adjustment knob per 1 level again to check if the wrinkle is gone.</p>
--	--	--

# 5. Button Functions

---

## 5.1 Regular Button Functions









This printer has two buttons for feed, pause or cancel errors. There are different functions in different modes, as shown in the following table:

Button	Printer status	Function	Description
<b>Feed button</b>	Ready	Feed	When the printer is ready (Blue LED ON), press this button once, and the label will advance to the front of the next label
<b>Feed button</b>	Wait for push button to print	Print next	When the button Demand function is activated, the printer will stop after printing and wait for the user to press this button before printing the next label.
<b>Pause button</b>	Print mode	Pause	When the printer is printing continuously, pressing the PAUSE button will pause printing. The power indicator is blue flashing. Just press the button again, and the print job returns to normal.
<b>Pause button</b>	Error occurred	Cancel error	When the error RED is on, press the PAUSE button once, the printer will cancel the error and resume printing function, and reprint the label layout when the error occurs.

## 5.2 Power-on Utilities

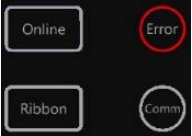
This printer has six power-on functions for setting or testing the printer's hardware. Press these buttons at the same time when the power is turned on, and release the buttons with the light signal to activate these functions.

Follow these steps to enable the boot function:

Event	Description	Status lights	Beep
<b>Self-test</b>	A. Power off the printer B. Make sure the printer is loaded with paper and close the printer cover C. Press and hold the FEED button and turn on the printer. When you hear a beep, release the FEED button. At this time, the printer will print a self-test page.		
<b>Enter USB storage device function</b>	A. Power off the printer B. Make sure the printer is loaded with paper and close the printer cover C. Press and hold the PAUSE button and turn on the printer. When you hear a beep, release the PAUSE button, and the printer's storage device will appear on the computer.		
<b>Enter dump mode</b>	A. Power off the printer B. Make sure the printer is loaded with paper and close the printer cover C. Press and hold the PAUSE and FEED buttons at the same time for two seconds, then turn on the printer's power. When the online Blue and the error Red are on at the same time, release PAUSE and FEED buttons, when you hear a beep, the printer enters the dump mode and will print out "NOW IN DUMP MODE"		
<b>Skip AUTO.BAS</b>	A. Power off the printer B. Press and hold PAUSE and FEED buttons for four seconds at the same time, and turn on the printer power until the power Blue is off, and the error Red is on, release PAUSE and FEED buttons, two beeps are heard. At this time, the printer will skip the AUTO.BAS program, and then the power light is on		
<b>Printer initialization</b>	A. Power off the printer B. Press and hold PAUSE and FEED buttons at the same time for six seconds, and turn on the printer power until the printer online Blue is on and error Red is off, release PAUSE and FEED buttons, five beeps are heard. At this time the printer will restore the printer parameters to the factory default settings		
<b>Ribbon inspection</b>	The machine will automatically detect the status of the ribbon after turning on and in each thermal transfer printing mode.		

# 6. PrinterUtility

Printer Utility is an integrated tool software that helps users query printer settings and status, change printer-related settings, and send commands or files to the printer.

## 6.1 Start the PrinterUtility

1. Please mouse over Printer Utility icon  Printer Utility.exe image Double click left mouse button.

2. After opening the main screen, you can see the following function items:

- (1) Port Settings
- (2) Printer Information
- (3) Printer Configuration
- (4) Printer Function
- (5) Command Tool
- (6) Language
- (7) About
- (8) Exit

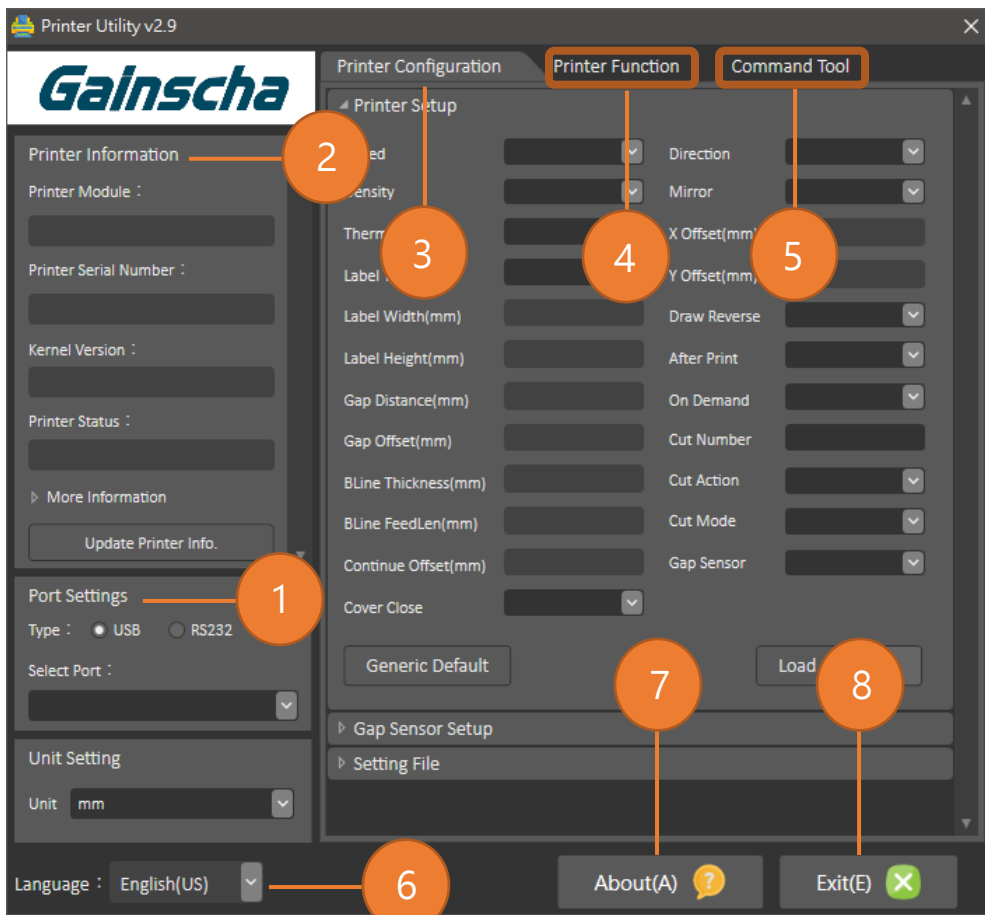

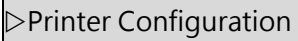
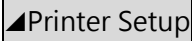

NOTE: If you need more detailed information, please refer to Gainscha official website <http://www.gainscha.com.tw/>

## 6.2 Printer Function

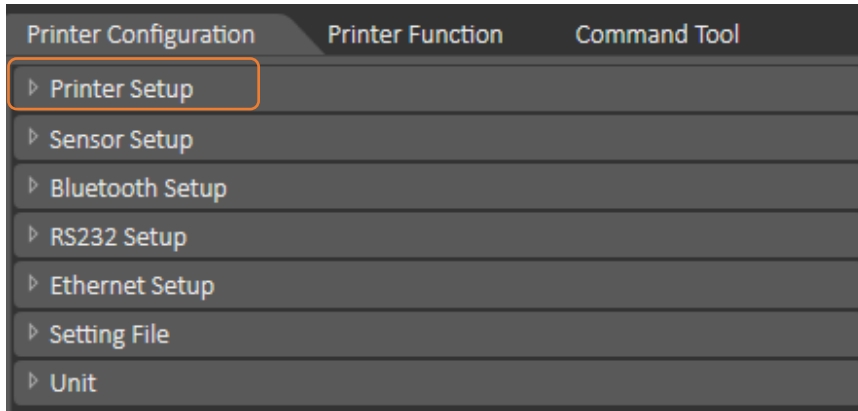
1. Click the  and  Can open and close the printer general settings screen.



2. Click the  Button to bring out all printer general setting information through the selected communication interface. Click the  button to write the setting value to the printer (please execute the reading function before writing).

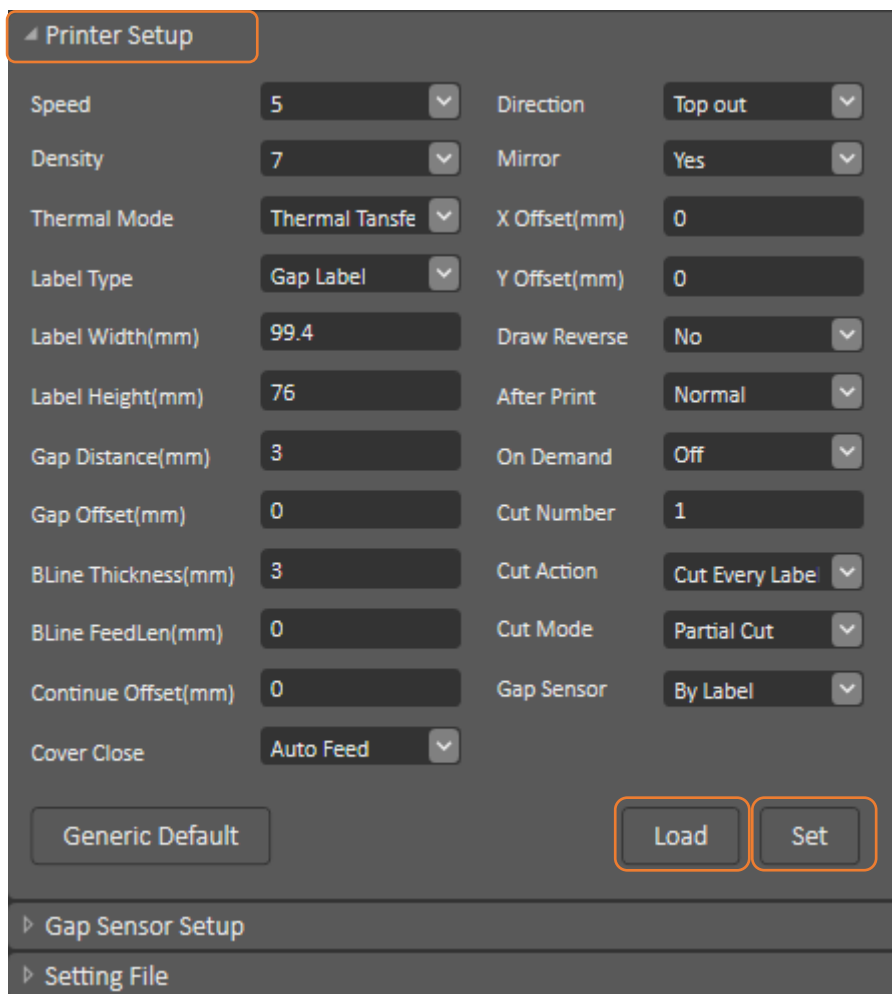



# 7. LCD Menu Function for GI-2410TM and GI-3407TM Series

---

## 7.1 Enter the Menu

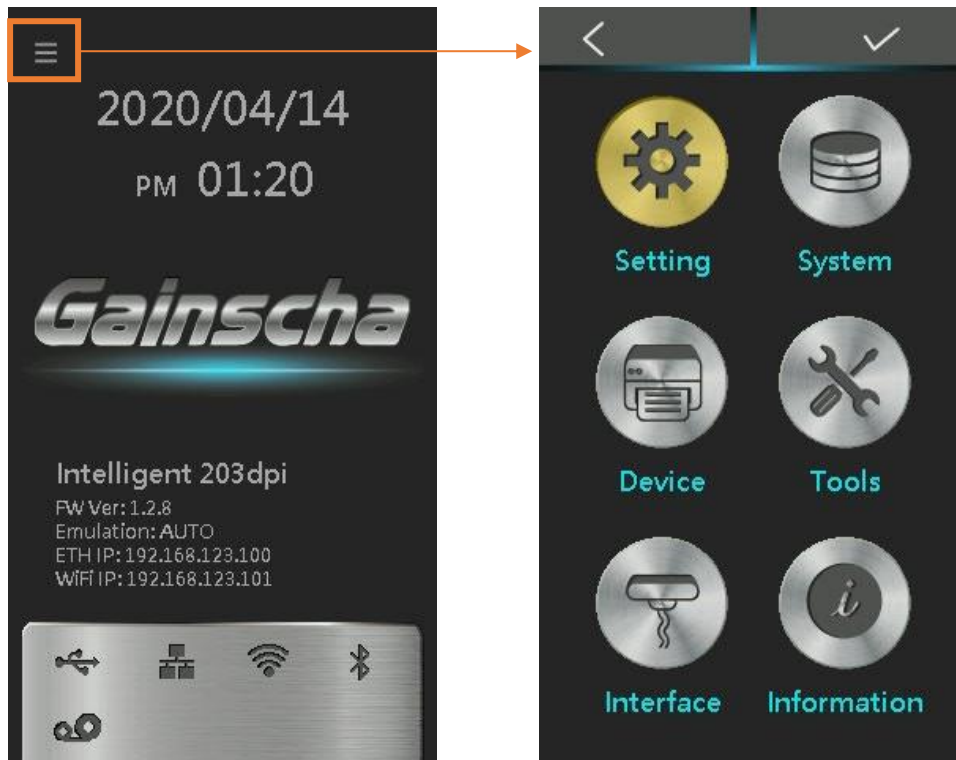

## 7.2 Menu Overview

There are 6 categories for the menu. You can easily set the settings of the printer without connecting the computer. Please refer to below for more details.

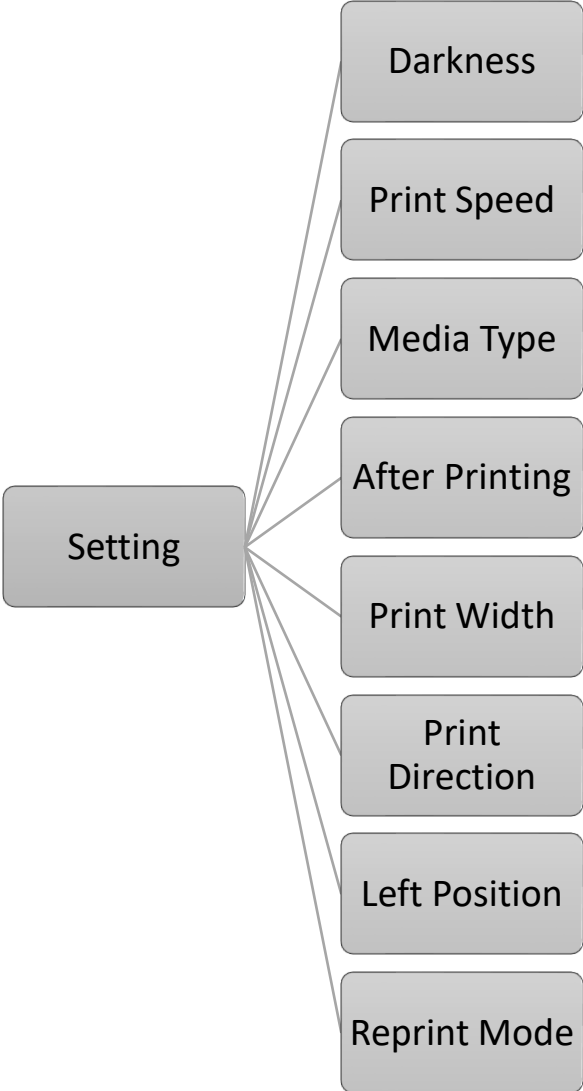
Button icon	function
	<p data-bbox="411 651 1088 689">This "Setting" option can set the printer function.</p>  <pre data-bbox="422 766 1007 1854">graph LR; Setting[Setting] --- Darkness[Darkness]; Setting --- PrintSpeed[Print Speed]; Setting --- MediaType[Media Type]; Setting --- AfterPrinting[After Printing]; Setting --- PrintWidth[Print Width]; Setting --- PrintDirection[Print Direction]; Setting --- LeftPosition[Left Position]; Setting --- ReprintMode[Reprint Mode];</pre>



This "Device" option can set the device function.

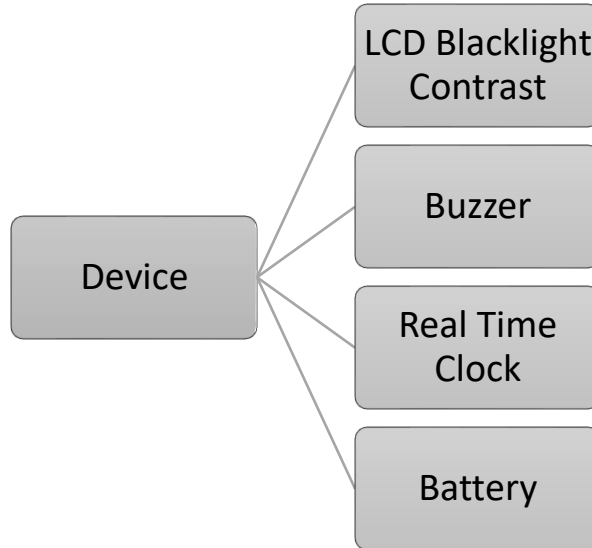

This "Interface" option can set the interface.

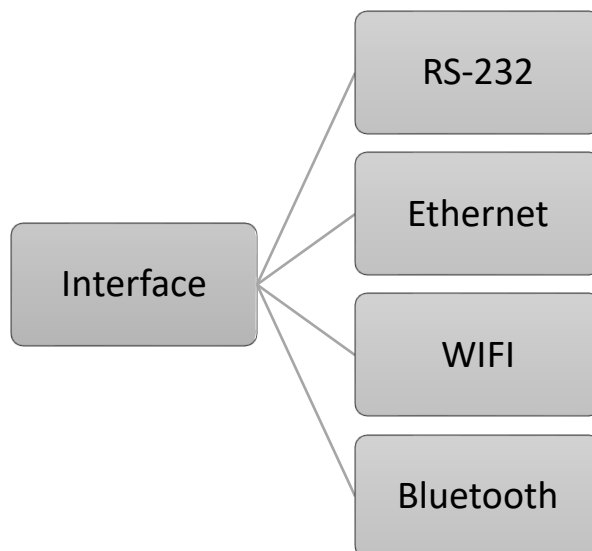



This "System" option can set the system parameters.

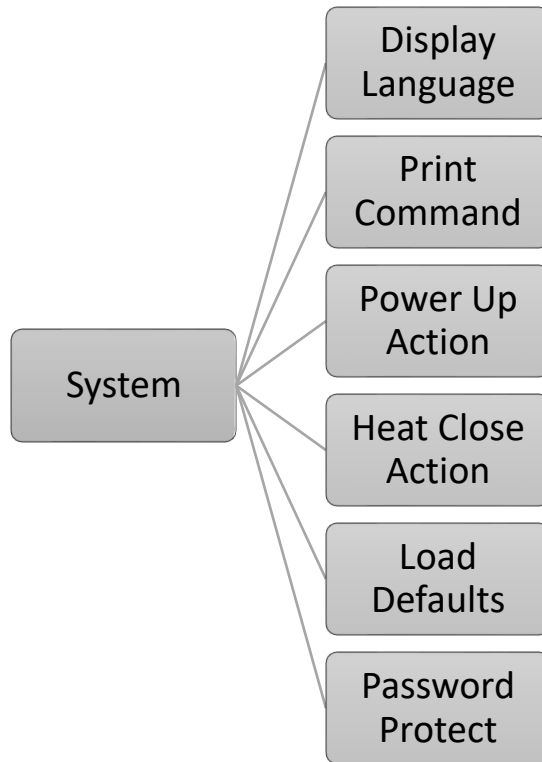

This "Tools" option can set the printer operation tool.

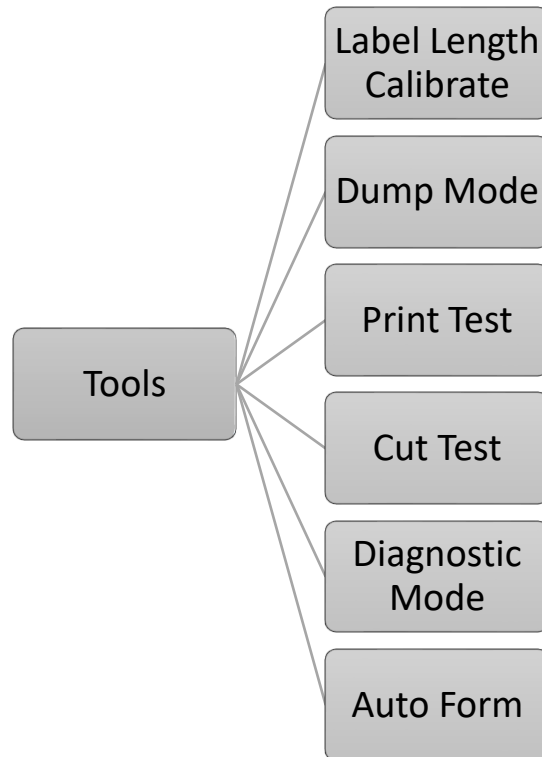



This "Information" option can inquire about the printer information.



# 8. Troubleshooting

## 8.1 Common Problems

The following guide lists the most common problems that may be encountered when operating this bar code printer. If the printer still does not function after all suggested solutions have been invoked, please contact the Customer Service Department of your purchased reseller or distributor for assistance.

Problem	Possible Cause	Recovery Procedure
Power indicator does not illuminate.	<ul style="list-style-type: none"> <li>● The power cord is not properly connected.</li> </ul>	<ul style="list-style-type: none"> <li>● Plug the power cord in printer and outlet.</li> <li>● Switch the printer on.</li> </ul>
Out of ribbon	<ul style="list-style-type: none"> <li>● Out of ribbon.</li> <li>● The ribbon installation path is incorrect.</li> </ul>	<ul style="list-style-type: none"> <li>● Install new ribbon.</li> <li>● Follow the steps for installing the ribbon to reinstall.</li> </ul>
Out of paper	<ul style="list-style-type: none"> <li>● Out of paper.</li> <li>● The paper installation path is incorrect.</li> <li>● Gap / black mark sensor detection is incorrect.</li> </ul>	<ul style="list-style-type: none"> <li>● Install new paper.</li> <li>● Follow the steps for installing the paper to reinstall.</li> <li>● Recalibrate the label sensor.</li> </ul>
Paper jam	<ul style="list-style-type: none"> <li>● Gap / black mark sensor detection is incorrect.</li> <li>● The label size is set incorrectly.</li> <li>● Label may be blocked inside the printer.</li> </ul>	<ul style="list-style-type: none"> <li>● Recalibrate the label sensor.</li> <li>● Set the correct label size.</li> <li>● Cleaning the inside of the printer.</li> </ul>
Unable to print	<ul style="list-style-type: none"> <li>● Cable is not well connected to serial or USB interface or parallel port.</li> </ul>	<ul style="list-style-type: none"> <li>● Re-connect cable to interface.</li> <li>● Change a new cable.</li> <li>● Ribbon and media are not compatible.</li> <li>● Verify the ribbon-inked side.</li> <li>● Reload the ribbon again.</li> <li>● Clean the print head.</li> <li>● The print density setting is incorrect.</li> <li>● Print head's harness connector is not well connected with printhead. Turn off the printer and plug the</li> </ul>

		connector again.
Poor print quality	<ul style="list-style-type: none"> <li>● Ribbon and media is loaded incorrectly.</li> <li>● Dust or adhesive accumulation on the print head.</li> <li>● Print density is not set properly.</li> <li>● Printhead element is damaged.</li> <li>● Ribbon and media are incompatible.</li> </ul>	<ul style="list-style-type: none"> <li>● Reload the supply.</li> <li>● Clean the print head.</li> <li>● Clean the platen roller.</li> <li>● Adjust the print density and print speed.</li> <li>● Run printer self-test and check the print head test pattern if there is dot missing in the pattern.</li> <li>● Change proper ribbon or proper label media.</li> <li>● The print head mechanism does not latch the print head properly.</li> </ul>
Skip labels when printing	<ul style="list-style-type: none"> <li>● Label size is not specified properly.</li> <li>● Sensor sensitivity is not set properly.</li> <li>● The media sensor is covered with dust.</li> </ul>	<ul style="list-style-type: none"> <li>● Check if label size is setup correctly.</li> <li>● Calibrate the sensor by Auto Gap or Manual Gap options.</li> <li>● Clear the GAP/Black mark sensor by blower.</li> </ul>
The printing position of small label is incorrect	<ul style="list-style-type: none"> <li>● Media sensor sensitivity is not set properly.</li> <li>● Label size is incorrect.</li> <li>● The vertical offset setting in the driver is incorrect.</li> </ul>	<ul style="list-style-type: none"> <li>● Calibrate the sensor sensitivity again.</li> <li>● Set the correct label size and gap size.</li> <li>● If using the software BarTender, please set the vertical offset in the driver.</li> </ul>
Missing printing on the left or right side of label	<ul style="list-style-type: none"> <li>● Wrong label size setup.</li> </ul>	<ul style="list-style-type: none"> <li>● Set the correct label size.</li> </ul>
Wrinkle problem	<ul style="list-style-type: none"> <li>● Ribbon installation is incorrect.</li> <li>● Media installation is incorrect.</li> <li>● Print density is incorrect.</li> <li>● Media feeding is incorrect.</li> </ul>	<ul style="list-style-type: none"> <li>● Please set the suitable density to have good print quality.</li> <li>● Make sure the label guide touch the edge of the media guide.</li> </ul>
Gray line on the blank label	<ul style="list-style-type: none"> <li>● The print head is dirty.</li> <li>● The platen roller is dirty.</li> </ul>	<ul style="list-style-type: none"> <li>● Clean the print head.</li> <li>● Clean the platen roller</li> </ul>
Irregular printing	<ul style="list-style-type: none"> <li>● The printer is in Hex Dump mode.</li> </ul>	<ul style="list-style-type: none"> <li>● Turn off and on the printer to skip the dump mode.</li> </ul>
Problem	<ul style="list-style-type: none"> <li>● Possible Cause</li> </ul>	<ul style="list-style-type: none"> <li>● Recovery Procedure</li> </ul>

# 9. Maintenance

This session presents the clean tools and methods to maintain your printer.

1. Please use one of following material to clean the printer.

- Cotton swab
- Lint-free cloth
- Vacuum / Blower brush
- 100% ethanol

2. The cleaning process is described as following,

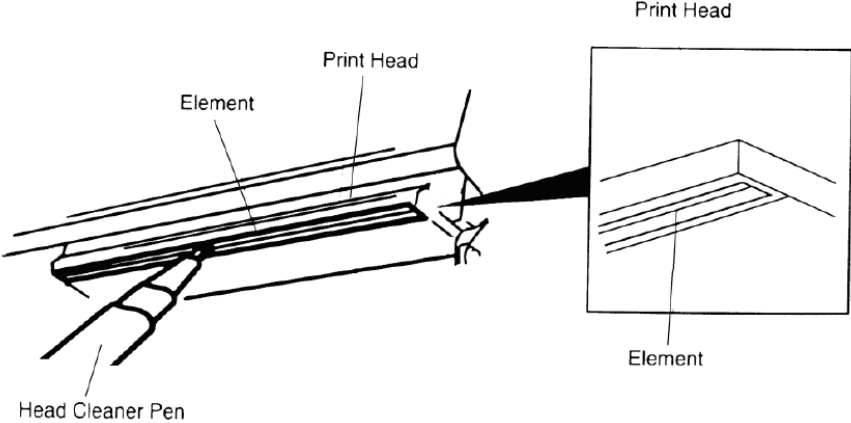
Printer Part	Method
Print Head	<p>1. Always turn off the printer before cleaning the print head.</p> <p>2. Allow the print head to cool for a minimum of one minute.</p> <p>3. Use a cotton swab and 100% ethanol to clean the print head surface.</p> 
Platen Roller	<p>1. Turn the power off.</p> <p>2. Rotate the platen roller and wipe it thoroughly with 100% ethanol and a cotton swab, or lint-free cloth.</p>
Tear Bar/Peel Bar	Use the lint-free cloth with 100% ethanol to wipe it.
Sensor	Compressed air or vacuum
Exterior	Wipe it with water-dampened cloth
Interior	Brush or vacuum

NOTE:

- Do not touch printer head by hand. If you touch it careless, please use ethanol to clean it.
- Please use 100% Ethenol.DO NOT use medical alcohol, which may damage the printer head.
- Regularly clean the print head and supply sensors once change a new ribbon to keep printer performance and extend printer life.
- The maximum printing ratio per dot line is 15% for this printer. To print the full web black line, the maximum black line height is limited to 40 dots, which is 5mm for 203 DPI resolution printer and 3.3mm for 300 DPI resolution printer.



# 10. Revise History

---

Date	Version	Content
2020/8/11	Ver.1.0.1	Modify chapter 5.2 Power-on Utilities Delete chapter 3.4.3 External Label Roll Mount Installation (Option)